



Technical Report - 2012 - 058



Common Implementation Strategy for the Water Framework Directive (2000/60/EC)

*Guidance Document No. 28
Technical Guidance on the Preparation
of an Inventory of Emissions, Discharges
and Losses of Priority and Priority
Hazardous Substances*

**Europe Direct is a service to help you find answers
to your questions about the European Union**

**New freephone number:
00 800 6 7 8 9 10 11**

A great deal of additional information on the European Union is available on the Internet. It can be accessed through the Europa server (<http://ec.europa.eu>).

ISBN : 978-92-79-23823-9

doi : 10.2779/2764

© European Communities, 2012

Reproduction is authorised provided the source is acknowledged.

Disclaimer:

This technical document has been developed through a collaborative programme involving the European Commission, all the Member States, the Accession Countries, Norway and other stakeholders and Non-Governmental Organisations. The document should be regarded as presenting an informal consensus position on best practice agreed by all partners. However, the document does not necessarily represent the official, formal position of any of the partners. Hence, the views expressed in the document do not necessarily represent the views of the European Commission.

**Common Implementation Strategy for the Water Framework
Directive (2000/60/EC)**

Guidance Document No. 28

**Technical Guidance on the Preparation of an Inventory of
Emissions, Discharges and Losses of Priority and Priority
Hazardous Substances**

FOREWORD

In 2000, the European Union Member States, Norway, and the European Commission jointly developed a common strategy for implementing Directive 2000/60/EC establishing a framework for Community action in the field of water policy (the Water Framework Directive). The main aim of this strategy is to allow coherent and harmonious implementation of the Directive. The focus is on methodological questions relating to a common understanding of the technical and scientific implications of the Water Framework Directive. In particular, one of the objectives of the strategy is the development of practical non-legally binding Guidance Documents on relevant technical issues. These Guidance Documents are targeted at the experts who are directly or indirectly implementing the Water Framework Directive in river basins. The structure, presentation and terminology are therefore adapted to the needs of those experts, and formal, legalistic language is avoided wherever possible.

Under the WFD Common Implementation Strategy, a Drafting Group was established in 2010 to produce guidance on the preparation of the inventory of emissions, discharges and losses, as required by Article 5(6) of the Environmental Quality Standards Directive 2008/105/EC. The Drafting Group worked under the umbrella of the CIS Working Group E on Chemical Aspects and was co-led by Germany, France and the Environment Directorate General. The Working Group E is chaired by the Commission and consists of experts from Member States, EFTA countries, candidate countries and more than 25 European umbrella organisations representing a wide range of interests (industry, agriculture, water, environment, etc.).

The Water Directors endorsed the Guidance during their informal meeting under the Polish Presidency in Warsaw (8-9 December 2011).

The Guidance is a living document that will need to be reviewed and improved as experience is gained in its application.

CONTENTS

| | |
|---|----|
| I. PURPOSE OF THE GUIDANCE | 6 |
| I.1 Introduction and legal requirements | 6 |
| I.2. Practical uses of emissions inventories (who will use them and for what purposes)..... | 8 |
| I.3. General approach and minimum expectations | 9 |
| II. DEFINITION OF TERMS | 12 |
| II.1. Discharges, emissions and losses..... | 12 |
| II.2. Sources..... | 13 |
| II.3. Pathways | 14 |
| II.4. Processes in the river system..... | 14 |
| II.5. Riverine load..... | 14 |
| II.6. Emission factor | 14 |
| III. GENERAL COMPONENTS OF AN INVENTORY | 16 |
| III.1. General working scheme | 16 |
| III.2. Spatial resolution of the inventory..... | 17 |
| III.3. Temporal scope of the inventory | 19 |
| III.4 Tiered Approach | 20 |
| IV. WORKING METHODOLOGIES | 23 |
| IV.1. General Description of existing methodologies | 23 |
| IV.1.1. Riverine load oriented approaches | 23 |
| IV.1.2. Pathway oriented approaches including hydrology-driven transfer processes | 25 |
| IV.1.3. Source oriented approaches (SFA, SOCOPSE project)..... | 27 |
| IV.2. Input data needs for the different approaches: building blocks, using existing EU and international data sources..... | 29 |
| IV.2.1. Legal data flows..... | 30 |
| IV.2.2. Voluntary data flows | 30 |
| IV.2.3. WISE..... | 30 |
| IV.2.4. Additional national/regional dataflows | 31 |
| IV.3. Proposed procedure for the compilation of the inventory | 33 |
| IV.4. Interpretation of the results from the different approaches..... | 36 |
| IV.4.1 Interpretation..... | 36 |
| IV.4.2 Comparison | 37 |
| IV.4.3 Use of results in water management processes..... | 39 |
| REFERENCES..... | 40 |
| GLOSSARY | 41 |
| PREPARATION OF THE GUIDANCE..... | 42 |
| ANNEXES: COUNTRY EXAMPLES..... | 43 |
| Austria case study fact sheet..... | 44 |
| Germany case study fact sheet I | 50 |
| Germany case study fact sheet II | 53 |
| Belgium (Flanders) case study fact sheet..... | 58 |
| France case study fact sheet..... | 63 |

I. PURPOSE OF THE GUIDANCE

I.1 Introduction and legal requirements

According to Article 5 of the Directive 2008/105/EC on Environmental Quality Standards in the Field of Water Policy (the EQS Directive), Member States (MS) are obliged to establish an inventory of emissions, discharges and losses of all Priority Substances (PS) and pollutants listed in Part A of Annex I to this Directive.

Pursuant to Article 5(6), technical guidelines for the establishment of inventories are to be adopted in accordance with Water Framework Directive (WFD) regulatory procedure. This guidance document aims to help MS establish the inventories and to reduce the burden by focusing on substances that are relevant at the River Basin District (RBD) level. European wide comparability of the results is another objective.

The inventories should give information on the relevance of PS at the spatial scale of the RBD or the national part of an international RBD, and on the loads discharged to the aquatic environment, thus supporting MS in subsequent river basin management and WFD implementation. For the public, the inventories should give greater transparency with regard to existing problems and on the need for measures to address them. Additionally these inventories will be used by the Commission for compliance checking with the environmental objectives of the WFD (WFD, Article 4) on reduction of discharges, emissions and losses for PS and cessation or phase out of discharges, emissions and losses for Priority Hazardous Substances (PHS). These inventories will be an important input for the Commission report according to Art. 7(1) of the EQS Directive on the possible need to amend existing acts, and the need for additional specific Community-wide measures such as emission controls.

Furthermore, the preamble of the EQS Directive (Recital 20) foresees the need to have an appropriate tool for quantifying losses of substances occurring naturally, or produced through natural processes, in which case complete cessation or phase out from all potential sources is impossible.

These inventories are to be compiled for every RBD or the national part of international RBDs and to provide not only yearly inputs but also to include, as appropriate, concentrations in sediment and biota (e.g. helping to substantiate the relevance of a substance for the RBD).

Article 5 of the EQS Directive requires MS to establish the inventory on the basis of information collected under Articles 5 and 8 of the WFD, under Regulation (EC) No 166/2006 and other available data. Each of these information sources is briefly described in the next section.

I.1.1 Information to be used in compiling the Inventory

Article 5 of Directive 2000/60/EC (the WFD) requires MS to provide, for each RBD, an analysis of its characteristics, a review of the impact of human activity on the status of surface waters and on groundwater, and an economic analysis of water use. Reports prepared under WFD Article 5 need to include, amongst other things:

- assessment of the likelihood that surface waters bodies within the RBD will fail to meet the WFD ecological and chemical status objectives;
- identification of significant point source pollution from urban, industrial, agricultural and other installations and activities; and
- identification of significant diffuse source pollution from urban, industrial, agricultural and other installations.

Article 8 of the WFD requires MS to establish programmes to monitor surface water status, groundwater status and protected areas, with the aim of establishing a coherent and comprehensive overview of water status within each RBD. For surface water monitoring programmes must include not only ecological and chemical status in accordance with the requirements of Annex V of that Directive, but also the volume and level or rate of flow as relevant to ecological and chemical status. Chemical status of surface waters is defined by Environmental Quality Standards (EQS), established to protect both environmental quality and human health. For groundwater such programmes are to cover monitoring of the chemical and quantitative status.

Regulation (EC) No 166/2006 concerns the establishment of a European Pollutant Release and Transfer Register (E-PRTR) at EU level in the form of a publicly accessible electronic database and lays down rules for its functioning, in order to; implement the UNECE Protocol on Pollutant Release and Transfer Registers; facilitate public participation in environmental decision-making and; contribute to the prevention and reduction of pollution of the environment. E-PRTR builds upon but also extends the principles of the European Pollutant Emission Register (EPER), requiring the reporting of pollutant ‘releases’ to water from industrial and other facilities, provided certain specified thresholds are exceeded.

Other available data encompasses monitoring data collected for other purposes (e.g. research studies, compliance monitoring for waste water discharges by Competent Authorities) describing, for example, substance concentrations in water, sediment and biota, and trend information. It also includes information describing the production and use of a substance and, if and when it has been banned or restrictions on its use have been implemented. Given the connectivity between ground and surface

water, those substances exceeding national groundwater thresholds can also be considered to be potentially of relevance.

I.1.2 Timetable

MS will establish the first inventories under the EQS Directive as part of the review of the WFD Article 5 analysis of pressures that is scheduled for December 2013. Both point and diffuse sources should be addressed. Article 5 of the EQS Directive requires the compilation update and reporting of the inventory on a regular basis as part of the river basin management process. Table 1 lists the relevant deadlines for the subsequent River Basin Management Plan (RBMP) cycles.

Table 1: Deadlines for the RBMP cycles

| Reporting under Article 13 of the WFD | Preparation of the inventory | Publication of the RBMP | Communication to the Commission |
|---------------------------------------|------------------------------|-------------------------|---------------------------------|
| 1st cycle of the RBMP | -- | 22.12.2009 | 22.03.2010 |
| 2nd cycle of the RBMP | 22.12.2013 | 22.12.2015 | 22.03.2016 |
| 3rd cycle of the RBMP | 22.12.2019 | 22.12.2021 | 22.03.2022 |
| | | | |

I.2. Practical uses of emissions inventories (who will use them and for what purposes)

This guidance applies to the substances contained in Annex 1, Part A of the EQS Directive. However, it is recommended that MS also use it to establish inventories for their national, regional or local specific pollutants (Annex VIII of the WFD).

In practical terms, an emission inventory should be seen as a tool which may be used to:

- assist in establishing and implementing targeted reduction of emissions, discharges and losses of PS eventually leading to the cessation of emissions, discharges and losses of PHS (e.g. by identifying the main sources, their relative share with respect to pollution and, their pathways);
- demonstrate the efficacy of RBMP Programmes of Measures (PoM);
- assess if or to what extent monitored concentrations are caused by natural sources or processes (e.g. geogenic background) or long-range transport processes;
- support the Commission in checking compliance with the environmental objectives under the WFD.

- assist in checking the effectiveness of measures implemented to achieve the reduction and phasing out of emissions required by the provisions of the WFD.
- identify gaps in knowledge and hence where there is a need to develop new strategies/policies.
- assist with the implementation of the Marine Strategy Framework Directive (MSFD).

An emissions inventory can therefore assist in a range of ways with the implementation of the WFD.

This guidance document is targeted at those experts who are directly or indirectly involved in the establishment, at the national level, of the inventories of emissions, discharges and losses. It will also support decision makers. The structure, presentation and terminology are therefore adapted to the needs of these categories of experts and formal, legalistic language is avoided wherever possible.

I.3. General approach and minimum expectations

An inventory of annual emissions, discharges and losses of PS is required at national RBD scale. It should in principle cover all substances listed in Annex I of the EQS-Directive.

The practical usefulness of an inventory in River Basin Management significantly increases with a more detailed analysis and higher spatial resolution (see section III.2 for a more detailed discussion on the spatial scale).

The scale of pressures caused by certain substances might be very different throughout Europe. Therefore a two-step analysis (Figure 1) is recommended, which allows for a prioritisation of resources to compile the inventory.

1) As a first step, an assessment of current relevance of the substances at the RBD level should be undertaken.

The aim of the first step is to identify those substances which are clearly of minor relevance for the RBD at present and in the foreseeable future and to concentrate the efforts of subsequent inventory development on the remaining substances. Consequently, the criteria for this first selection round must not be too strict.

This assessment of relevance should draw upon the information sources identified in Article 5 of the EQS Directive (see Section 1.1), namely the results of the WFD compliance monitoring as well as information on existing restrictions on production and marketing. Using this information a set of transparent criteria should be applied for this initial assessment. A substance should be included for in-depth inventory compilation if at least one of the following possible criteria (when considering data from the last 3-5 years) is met:

- The substance causes a failure of good chemical status in at least one water body

- The level of concentration for a substance is above half of the EQS in more than one water body
- Monitoring results show an increasing trend of concentration which may cause problems within the next RBMP cycles
- PRTR data show releases which might lead to concentrations matching the criteria above
- Known sources and activities causing inputs in the RBD exist which might lead to concentrations matching the criteria above.

This selection criteria and results should be reported in the inventory. For the substances discarded (i.e. for substances of minor relevance) MS should try to provide a basic estimation of emissions, discharges and losses from available data. This is especially important for PHS.

2) As a second step, for the substances which pass the relevance criteria a more detailed analysis using a tiered approach should be performed. It should aim at providing further estimates of emissions, discharges and losses from point and diffuse sources, as well as loads transported in rivers.

The analytical approach chosen (from those in chapter III.4) should be based on the required output information, the available data and practical experience.

As a minimum requirement for the first inventory, point discharges of PS from industrial facilities and municipal wastewater plants (e.g. as required to be reported under E-PRTR) and, a basic or approximate estimation of diffuse inputs, via, for example, the calculation of riverine loads should be provided. The riverine load approach has the advantage of a) being an approach that a number of MS will have already adopted under regional sea conventions such as OSPAR and HELCOM and; b) providing a means of verifying estimates arising from other methodologies.

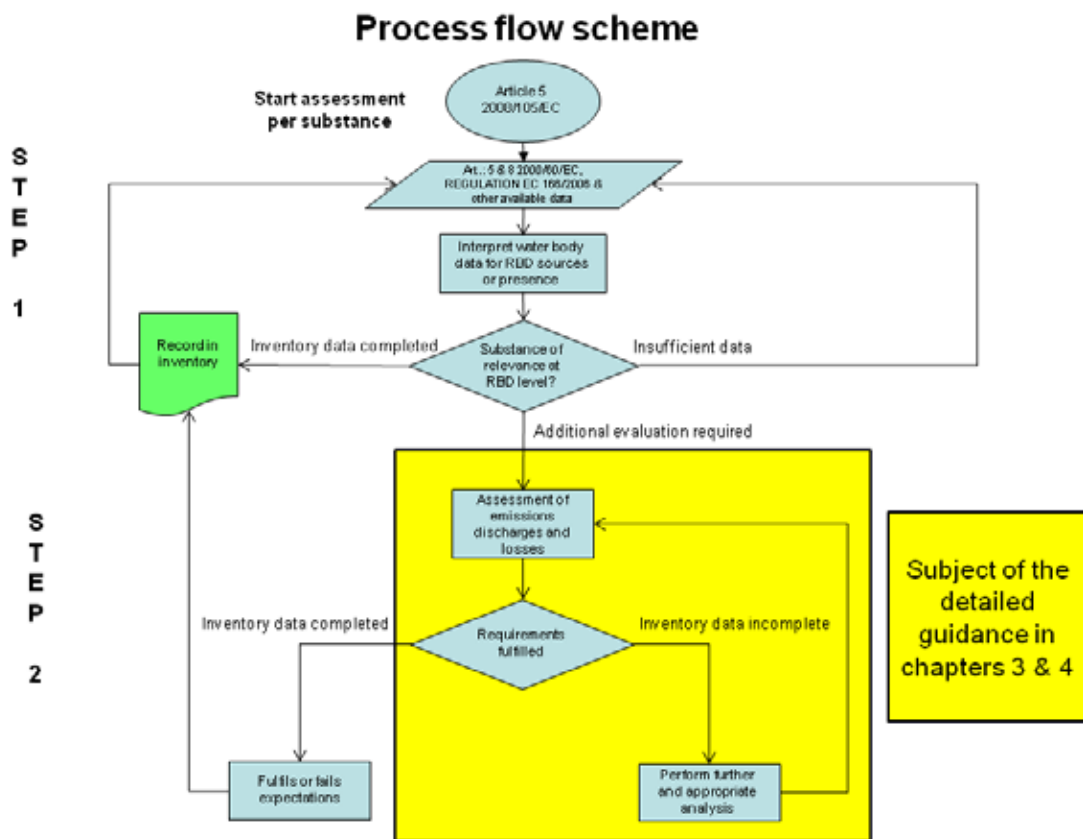

Figure 1: Overview of the 2-step inventory building process

For the first inventory, one year's worth of data is required between 2008 and 2010 (see section III.3 on temporal scale). Since diffuse inputs are strongly and positively correlated with rainfall/river flow (diffuse inputs can increase markedly in wet years) this has to be taken into account.

Where ‘higher tier’ methods are introduced, re-calculation of more basic estimates for earlier reporting dates should be undertaken and reported. In this way, not only will the quality of the original estimate be improved but consistency in methodology over time is maintained.

II. DEFINITION OF TERMS

II.1. Discharges, emissions and losses

The term “discharges, emissions and losses” was used for the first time in the Esbjerg Declaration of the 4th North Sea Conference in 1995¹ with respect to the prevention of pollution by hazardous substances.

The use was in conjunction with the “*generation goal*” which is described as “*the prevention of the pollution of the North Sea by continuously reducing discharges, emissions and losses of hazardous substances thereby moving towards the target of their cessation within one generation (25 years) with the ultimate aim of concentrations in the environment near background values for naturally occurring substances and close to zero concentrations for man-made synthetic substances.*”

This somewhat complicated term “discharges, emissions and losses” was chosen in the Esbjerg Declaration to make it clear that all inputs

- coming from land and sea based sources,
- coming from point and diffuse sources,
- reaching the marine environment via direct discharges, riverine inputs or airborne transport,

are addressed and have to be included in the required reduction measures to reach the generation goal.

The requirements of Art. 16 of the WFD regarding PHS also have their origin in the North Sea generation goal and aim to make it operational.

Although some terms (e.g. emissions) have been defined elsewhere in other legislation (e.g. the IPPC Directive²) the overall meaning of “discharges, emissions and losses” has not changed. Consequently, in the context of the PS inventory “emissions, discharges and losses” should be used in this broad sense.

Thus, for the purpose of the inventory the term “discharges, emissions and losses” means that the inventory has **to address all inputs of the relevant substances into the environment, irrespective of the compartment involved, that are likely to reach surface waters (the main routes of transport into surface waters are described in III.1)**. So, for example, a restriction to point sources only, without a comprehensive justification of why this would be the only relevant input route to the aquatic environment, clearly would not meet the requirement of the EQS Directive.

¹http://www.ospar.org/html_documents/ospar/html/4NSC-1995_Esbjerg-declaration.pdf

In this guidance document, “input” is used as a generic term for the movement of a substance into the aquatic environment.

II.2. Sources

In the conceptual framework of this inventory, all processes and activities that are likely to contribute to the input of pollutants into the environment are defined as sources.

The reader should bear in mind that the principal focus of this guidance is the identification and quantification of anthropogenic sources, although some substances may also have a significant naturally occurring source.

For pragmatic reasons it is useful to distinguish between point and diffuse sources.

A **point source** is a single localized point of discharge of wastewater containing one or more pollutant(s). The most important ones are industrial facilities, waste water treatment plants (although strictly speaking the plant itself is not the source), untreated sewage, waste disposal systems and mining sites³. Some of these sources are also modelled as diffuse sources due to data restrictions.

The E-PRTR Regulation (EC) No 166/2006 gives the following definition of **diffuse sources**: “*diffuse sources*’ means the many smaller or scattered sources from which pollutants may be released to land, air or water, whose combined impact on those media may be significant and for which it is impractical to collect reports from each individual source”. Diffuse sources include agricultural activities, some urban related emissions, atmospheric deposition, and rural dwellings. Typically, they are more variable in space and time than point sources.

Regarding Plant Protection Products (PPPs) in agriculture, the definition of point source and diffuse source is different from that described above due to the specific temporal and spatial context. "Point source" for PPPs includes any spills of concentrated or diluted PPP during transport, storage, filling, spraying, cleaning, management of residual spray and maintenance. In particular it includes use or handling in areas not covered by approved label recommendations for spraying or guidance/codes of practice for correct filling, cleaning or disposal. It also includes uncontrolled release of an excessive amount of PPP during treatment (overdosing). "Diffuse source" for PPPs is related to undesired movement of PPPs in soil, water or air following application on crops and within areas agreed for use

²Directive 2008/1/EC of the European Parliament and of the Council of 15 January 2008 concerning integrated pollution prevention and control

³ The general term mining sites comprises active and abandoned/historic sites. Active modern mining sites operate well-organised waste water treatment and therefore correspond to point sources. In Fig 2 they are considered in the box Industry and in pathway 10. In contrast the discharges from abandoned or historic mining sites may arise from a distinct point, such as waste water treatment, or be scattered and untreated. Emissions from abandoned or historic mining may therefore correspond to pathway 10 or 11.

according to approved label recommendations. These definitions may be relevant to pesticides other than PPPs, e.g. certain biocides, depending upon their mode of use.

Due to the discrepancies in the definitions of diffuse and point sources, whether an input is dealt with as a diffuse or a point source must be documented in the inventory.

II.3. Pathways

Pathways are the means or routes by which specific substances can migrate or are transported from their various sources to the aquatic environment. Following release, substances may be directly emitted to a waterbody or transferred to and stored within environmental media including soil and impermeable surfaces, before entering the aquatic environment. Aerial emission is an important pathway for certain PS and can result in subsequent direct deposition to a waterbody or indirect entry via soil or a sewer system.

II.4. Processes in the river system

In surface waters a wide range of processes occur, e. g. sorption on suspended particles, degradation, biodegradation, biotransformation or bioaccumulation in plants or animals. Retention is a broad term used to describe the outcome whereby loads from sources entering surface water remain there, without for example being discharged to coastal waters. The fractions that are retained have the potential to become mobilised in the future, however, this is not always the case. The extent of retention depends on the physical-chemical properties of the PS as well as on the flow velocity of the river, type and number of particles in the water or the available retention area such as wooded floodplains.

II.5. Riverine load

Riverine loads describe the mass of a contaminant transported per unit of time, typically expressed as kg or tonnes per year. Their calculations have value with respect to establishing a PS emissions inventory for two reasons:

- 1.) The load for any given contaminant reflects the sum of inputs upstream of the monitoring point at which these are calculated. As such these provide a check or means of validation - the sum of inputs from individual and separate sources should broadly equate to the total riverine load;
- 2.) Riverine loads can be used to estimate and/or verify the contribution from diffuse sources.

II.6. Emission factor

An emission factor is a coefficient linking the estimated average quantity of emission of a given pollutant during a representative time interval to an easily accessible emission variable, also called characteristic unit (inhabitant, p.e., car, ha of land...) with the following formula:

$$\text{Estimated emission} = \text{number of characteristic units} \times \text{emission factor}$$

Most emission factors are developed by taking the average measured pollutant quantity, measured at easily accessible points (stack, discharge point...), for a representative sample of the targeted sources, during a representative time interval. The average measured pollutant quantity is related to the extent of the activity for which emission estimation is needed using a quantitative unit, the characteristic unit, for which statistics are easy to obtain from several bibliographical sources (trade associations, national statistics, research institutes databases ...).

The application of emission factors will provide information about the average emission of many installations but cannot provide reliable data for a single installation.

III. GENERAL COMPONENTS OF AN INVENTORY

III.1. General working scheme

The principal components of the inventory and their inter-linkages are shown in Figure 2. The main routes of transport into surface waters are shown from left to right.

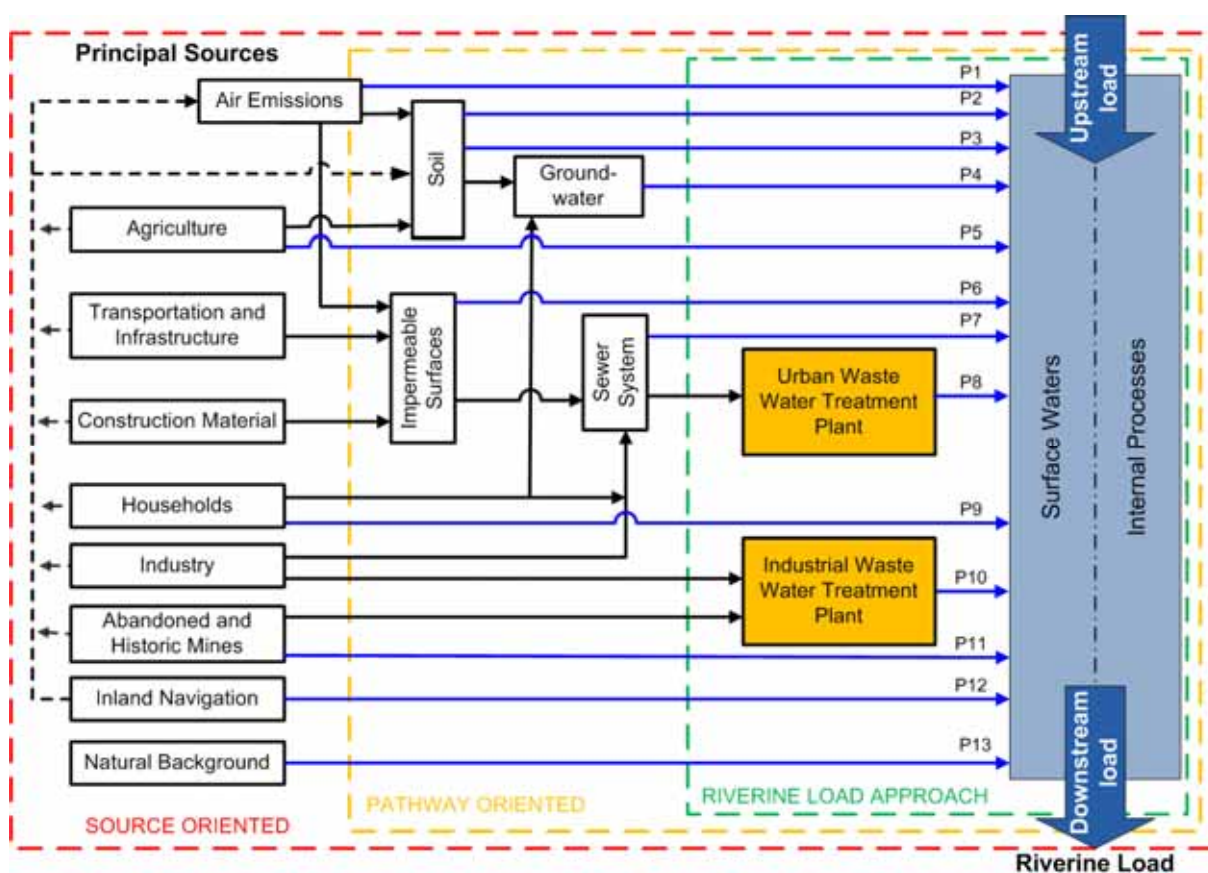

P1: Atmospheric Deposition directly to Surface Waters

P4 Interflow, Tile Drainage and Groundwater⁴

P7: Storm Water Outlets, Combined Sewer Overflows and Unconnected Sewers

P10 Industrial Waste Water treated

P13 Natural Background

P2: Erosion

P5: Direct Discharges and Drifting

P8: Urban Waste Water Treated

P11: Direct Discharges from Mining Areas⁵

P3: Surface Runoff from Unsealed Areas

P6: Surface Runoff from Sealed Areas

P9: Individual - Treated and Untreated-Household Discharges

P12: Direct Discharges from Navigation⁶

Figure 2: General working scheme of the inventory

⁴ This pathway comprises also emissions from contaminated land

⁵ A portion of the total emissions from abandoned and historic mining sites is discharged to groundwater. Active mines are covered under "Industry".

⁶ Inland navigation also comprises waterway construction materials.

The most important sources for the release of substances into the environment are shown on the left of the figure. Substances may be released to water, air or soil. Direct input routes into surface water are indicated by blue arrows, other transport routes by black arrows.

Substance inputs into waste water should undergo treatment in Urban Waste Water Treatment Plants (UWWTPs) before entering surface waters. Substances emitted indirectly to surface waters may be first temporarily detained in “interface media” like soil or impermeable surfaces, and then subsequently transported to surface waters by other processes (erosion, urban storm water etc.). Some of these intermediate processes may take a very long time (decades and beyond) to reach surface waters. The interface media are shown in the middle part of the figure.

The internal removal, transport or storage processes in the surface water itself (like degradation, sedimentation, re-suspension) are indicated on the right side of the figure. So the quantity to be observed (the load in the river system) is the result of all these indicated processes and their respective time constants.

Due to the complexity of the system and the challenges associated with data collection, different approaches arise with respect to the establishment of inventories. In principle, three broad approaches can be distinguished:

- the riverine load oriented approach, which estimates the observed total load in the river. This information can be used together with a quantification of point source inputs to calculate an estimate of the diffuse inputs.
- the pathway oriented approach, also called Regionalised Pathway Analysis (RPA), models the different transport phenomena for the final input routes to the river system starting from the “interface media”. This approach calculates regionalised emissions for small catchments (termed analytical units) which can be subsequently aggregated to RBDs or sub-units.
- the source oriented approach addresses the whole system starting from the principal sources of substance release. Such an approach includes Substance Flow Analysis (SFA).

The scope of these approaches is indicated by the dashed boxes in diagram. The complexity of the approaches increases from right to left. The different approaches are discussed in more detail in chapter IV; limitations of the different approaches are discussed in III.2.

III.2. Spatial resolution of the inventory

The EQS Directive formally requires a spatial resolution of the inventory at RBD scale or the national part of an international RBD. The current reporting practice for the RBMP requests information on the sub-unit scale to improve pan-European comparability (5000-50000 km²). The inventory is not aimed at waterbody level.

Regarding the usefulness of the inventory for RBMP purposes, e.g. for identifying hot spots (areas with high specific inputs of substances) or estimating the effectiveness of measures, a significantly higher spatial resolution (~100~1000 km²) is desirable. To support water management at a local scale, an even higher spatial resolution is necessary.

The spatial resolution of substance inputs is determined by the nature and distribution of sources (location of production and consumption sites, including share and type of agricultural land), and the structure and characteristics of transport pathways to surface water (e.g. regional geography and the regional meteorological and hydrological situation).

Point source information can normally cover all spatial requirements, as the inputs are located at the point of discharge, but if emission factors have to be used the spatial resolution is lower, as the specifics of the installation concerned are not covered.

The determination of the spatial distribution of inputs is dependent on the estimation methodology applied. When estimating substance inputs via the monitoring of riverine loads, the area covered by the inventory is by definition the whole catchment upstream of the monitoring station investigated. Neglecting the problems of load monitoring, the observed (measured) loads are the sum of all inputs plus all transport phenomena (remobilization) minus the sum of all retention processes (degradation and intermediate storage processes). Estimated contributions of larger tributaries are only accessible using proxy parameters like area or population share. This is generally only a rough estimate.

When applying the RPA (pathway oriented approach) method the spatial resolution is theoretically limited by the size of the catchments (Analytical Units) used in the emission calculations, which are normally in the range of 100-1500 km². Thus the possible spatial resolution overlaps well with the resolution required for RBMP purposes. However, normally due to limitations in the quality and resolution of required input data, the practical resolution is lower. Often only average values for the whole river basin can be given. As data availability differs significantly for (priority) substances, only a few substances can be covered at present by RPA with a spatial resolution of 100 - 1500 km².

Local models are normally highly adapted to the specific situation of the target areas. The problem then is how the model can allow reasonable generalisation to larger areas (RBDs). This is strongly model dependent.

Substance Flow Analysis (SFA) investigations are limited in their regional scope as the required input data (e.g. production and consumption figures or estimates thereof) are only available from national or EU-wide statistics. In addition, regionalisation of emission factors requires an extensive compilation of analytical results and their corresponding metadata. So, when using SFAs, even regionalisation on RBD level is normally only possible using proxy parameters like population share.

In conclusion, the spatial resolution achievable will be a compromise between the size of the problem, the required information, the availability of data and the resources required. Thus it is likely that the methods used and the spatial resolution achieved will vary between substances.

III.3. Temporal scope of the inventory

The inventories aim to provide information on the yearly inputs of the PS at a certain point in time (reference period). Emissions discharges and losses are not always steady throughout the year and the impact on aquatic environment of peak inputs can be higher than the same quantity emitted at a steady state over time. However this temporal disaggregation is not targeted by the inventory since it is already addressed through the EQS and associated monitoring and compliance checking.

As emission processes, particularly diffuse ones, are strongly dependent on the hydrological situation, interpretation of the results requires a separation and discrimination of the hydrological effects from trends and changes caused by anthropogenic activities. This is especially important when evaluating and interpreting trends which are clearly dominated by hydrological variation. The offered option for PPPs is one possibility to account for these effects.

Article 5(2) of the EQS Directive states that the reference period for the first inventory is one year between 2008 and 2010. For PS covered by Regulation (EC) No 1107/2009⁷ on PPPs also the average of the years 2008-2010 may be used. For the updates of the inventories, the reference period is the year before that analysis is to be completed. For PPPs again the average of the three years before completion may be used. The specific 3-year-average option for PPPs is explained in Recital 23 with the *“fact that the losses from the application of pesticides may vary considerably from one year to another because of different application rates, for instance as a result of different climatic conditions.”*

Inventories of inputs of PPPs need to consider 3 - 5 years average so as to minimize the yearly variation in emission due to variation of climatic conditions involving variation of pest pressure and so significant difference in yearly use of PPPs. Choice of the years on which to calculate the average needs to consider possible changes in approved uses over the years. It could be, for example, that the approved use of a substance is currently restricted to greenhouse use only, when in previous years the substance was used on cereals. In such cases the average calculation needs to cover years with the same approved usage; separate averages should be provided for different usage periods.

⁷ Regulation (EC) No 1107/2009 of the European Parliament and of the Council of 21 October 2009 concerning the placing of plant protection products on the market and repealing Council Directives 79/117/EEC and 91/414/EEC

A similar approach is used in the regionalised path analysis where results are calculated on a yearly basis but published as 3-5 years average values. Another possibility is the calculation of inputs and adjustment of riverine loads using the long-term average hydrological conditions. Alternatively, riverine loads from any given year can be flow normalized.

| | |
|---|--|
| <p>Look out</p>  | <p>Nominally the reference period is the start of the RBMP cycles, providing information at the beginning of each cycle on the effects of the measures taken in the previous cycle. Given the complexity of the emission monitoring and estimation methods, the term "reference period" does not mean that only data generated during the reference period may be used. All data may be used if they are required in order to draw an adequate picture of the emission situation in the reference period. This is particularly important given that the guidance on inventory provisions had not been agreed prior to the conclusion of the period documented in the Directive. The selection of data should be justified by expert judgment and documented in the inventory.</p> |
|---|--|

III.4 Tiered Approach

The in depth analysis for the relevant substances can be performed with different approaches.

The approaches described in this guidance document vary in their complexity in order to account for the wide range of information and data sources available across MS. A tiered (or level) approach is presented whereby the complexity increases with each progressive rise in the tier.

Associated with a tier rise is an increase in understanding of sources and pathways, resolution and detail, all of which aids the identification of appropriate measures.

Improvements associated with higher tier approaches include; a greater discrimination of 'true sources', for example, the relative contribution of those sources emitting PS to sewers and UWWTPs, rather than the (lower tier) reporting of a lumped treated effluent discharge which does not allow for discrimination of the original source. Similarly, higher tier methods can discriminate original sources within the transport sector such as brake and tyre wear; greater geographical detail (from basin through to waterbody); improved temporal information (from once in a few years to annual or even seasonal); and the use of location-specific emission factors, production data (life-cycle assessment information) and detailed statistical data. Thus the different tiers support a progressively improved understanding of the emission situation and, therefore, the ability to effectively allocate financial resources.

Table 2 summarises the steps / approaches in compiling the inventory, the information required and the increase in output information which may be gained. Step 1 is the check for relevance of a substance. The criteria are described in chapter I.3.

For the relevant substances, the first two approaches of Step 2 (Table 2) must be undertaken in order to meet the requirements of the first round of reporting. It is anticipated that methodologies will generally become more sophisticated with later reporting cycles, however, MS may already choose to adopt a higher tier approach for the first round of reporting. Where methods are improved over time using higher tier approaches (tier 3 and 4), re-calculation of the more basic estimates for earlier reporting dates should be undertaken and reported. In this way, not only will the quality of the original estimate be improved but consistency in methodology over time will be maintained.

Table 2: Scheme of tiered approach for establishing an inventory, indicating complexity and information content

| TIER | BUILDING BLOCKS | EXPECTED OUTPUT | RESULTS FOR THE INVENTORY |
|---|--|--|---|
| STEP 1: ASSESSMENT OF RELEVANCE | | | |
| | Information sources identified in Art. 5 of EQS directive, see section I.1 | Decision of relevance | List of relevant and less relevant substances |
| STEP 2: APPROACHES FOR RELEVANT SUBSTANCES | | | |
| 1. Point source information | <ul style="list-style-type: none"> Data on point sources Emissions factors | <ul style="list-style-type: none"> Availability of data Quality of data Identification of gaps | <ul style="list-style-type: none"> Point source emissions Listing of identified data gaps |
| 2. Riverine load approach | add: <ul style="list-style-type: none"> River concentration Data on discharge In stream processes | <ul style="list-style-type: none"> Riverine load Trend information Proportion of diffuse and point sources Identification of gaps | <ul style="list-style-type: none"> Rough estimation of total lumped diffuse emissions Verification data for pathway and source orientated approaches Listing of identified data gaps |
| 3. Pathway orientated approach | add: <ul style="list-style-type: none"> Land use data Data on hydrology Statistical data | <ul style="list-style-type: none"> Quantification and proportion of pathways Identification of hotspots Information on adequacy of POM | <ul style="list-style-type: none"> Pathway specific emissions Additional spatial information on emissions |
| 4. Source orientated approach | add: <ul style="list-style-type: none"> Production and use data e.g. from REACH SFA Substance specific emission factors | <ul style="list-style-type: none"> Quantification of primary sources Complete overview about substance cycle Information on adequacy of POM | <ul style="list-style-type: none"> Source specific emissions Total emissions to environment and proportion to surface waters |

The method of deriving information for the inventory will vary depending upon a range of factors including data availability and available resources. In any given RBD different methodologies will be selected for different substances through a process of identification of relevant and less relevant substances and a subsequent focus on the most important problem substances.

Four levels or “tiers” of emission estimation methods can be distinguished:

Tier 1: Point Source Information:

This tier focuses on point source information. It uses readily available statistical data including point source information reported under E-PRTR. Based on this information, the presence or absence of known point sources can be concluded. The conclusion of absence should be backed up through the analysis of production and use information. If this confirms that the point emission of a substance is negligible, then final confirmation should be provided from the results of emission monitoring, which should be undertaken using appropriate methods. For all relevant hazardous substances this tier is mandatory, as it forms the basis of diffuse sources assessment.

Tier 2: Riverine Load Approach

It is based on concentration (both for the water and the suspended solids phase) and discharge data in rivers considering the basic processes of transport, storage or temporary storage and degradation of substances. The resulting riverine load provides information about the recent status of pollution and if long-term information is available then temporal trends too. In combination with the information gained in tier 1 it allows the allocation of observed loads to point and diffuse sources (a basic source apportionment). If the riverine load is equal to or less than the point source load calculated in tier 1, and the database, especially regarding concentration data, delivers reliable information, then the requirements for an inventory might be met. High pollutant concentrations, an increasing trend, or a high relevance of diffuse sources point to the need for a more detailed analysis using the approaches in tiers 3 and 4.

Tier 3: Pathway Oriented Approach

It uses more specific information about the land use, hydrology and basic transport processes involved. The data requirements are higher than for the lower tiers, but the level of information available for the inventory and management plans is even higher. This tier allows identification of the main sources and regional hotspots of emission and, a holistic overview of emission status, providing specific emissions (e.g. area specific loads, storm water runoff loads). It will, therefore, provide the basis for an accurate inventory. For substances following a ubiquitous emission pattern or for which efficient mitigation measures are not available it might be appropriate to enter the next tier.

Tier 4: The Source Oriented Approach (SOA)

It is based on substance-specific information on production, sales and consumption which to some extent are available through REACH. It allows the drawing of a comprehensive picture of the life cycle of a substance. The benefit of this approach is that the information gained is precise enough to implement not only end-of-pipe solutions but also source controls and precautionary measures.

IV. WORKING METHODOLOGIES

IV.1. General Description of existing methodologies

IV.1.1. Riverine load oriented approaches

Background

Riverine loads describe the mass of a contaminant transported per unit of time, typically expressed as kg or tons per year. Their calculation has value with respect to establishing a PS emissions inventory for two reasons:

- Riverine loads for any given contaminant reflect the sum of inputs to surface water from all sources upstream of the monitoring point at which they are calculated. As such they provide a check or means of verification – the sum of inputs from individual and separate sources should broadly equate to the total riverine load (provided any in-river processing is accounted for).
- Total riverine contaminant loads can be used - provided certain other information is available - to estimate and/or validate the contribution of that contaminant from diffuse sources; diffuse inputs are not readily calculable and typically require the use of estimation tools and models.

Estimation of riverine load

The load of a contaminant transported by a river is estimated by taking the product of the mean flow weighted concentration and the total river flow, expressed by the following formula (OSPAR, 2004a);

$$Ly = \frac{Q_d}{Q_{Meas}} \cdot \left(\frac{1}{n} \sum_{i=1}^n C_i \cdot Q_i \cdot U_f \right)$$

Ly = annual load (t/yr)

Qd = arithmetic mean of daily flow (m³/s)

Qmeas = arithmetic mean of all daily flow data with concentration measurement (m³/s)

Ci = concentration (mg/l)

Qi = measurement of daily flow (m³/s)

Uf = correction factor for the different location of flow and water quality monitoring station

n = number of data with measurements within the investigation period

Periods of high river flow typically carry a disproportionately large amount of the annual load of a contaminant. To avoid the underestimation of annual loads it is, therefore, important that water quality sampling strategies are designed to capture periods of high river flow. Sites selected for sampling should be in a region of unidirectional freshwater flow in an area where the water is well mixed and of uniform quality. Both the particulate and soluble load of a contaminant should be quantified. OSPAR, (2004) provides guidelines with respect to concentrations that are less than the limit of detection. These involve the calculation of two load estimations, one assuming that the true concentration is zero and the other assuming that the true concentration is the limit of detection. This approach derives maximum and minimum concentrations within which the true estimate will fall, providing upper and lower bounds for the load estimate. Other approaches are used as well, e.g. using 50% of the limit of quantification. The method used in load calculation has to be transparently documented and reported.

Flow normalisation

Riverine contaminant loads, and in particular certain diffuse source components, vary strongly with rainfall and hence river flow; typically the wetter the year, the higher the loading. Without the application of flow normalisation procedures, natural inter-annual variations in flow can mask or lead to misinterpretation of trends in contaminant loads. Genuine reductions in pollutant inputs attributable to the implementation of measures, for example, can be masked by the occurrence of higher annual river flow during more recent monitoring. Conversely, an apparently declining trend can be incorrectly attributed to the success of measures, but in reality reflects a drier year or years. Flow normalisation addresses this issue and can be undertaken via a variety of methods. Harmonised flow normalisation procedures are given by OSPAR, 2004a.

Estimation of diffuse loads

Riverine loads can be used to calculate diffuse and unknown inputs of PS providing point source information is available. In the most basic approach, the diffuse load can be estimated as the difference between the total load and the load discharged from point sources, as follows:

$$LDiff = Ly - Dp$$

Where, for a given contaminant, LDiff is the anthropogenic diffuse load, Ly is the total annual riverine load, and Dp is the total point source discharge. Such an approach ignores any potential in-river processes such as sedimentation and remobilisation, but provides a useful approximate means of estimating the diffuse load of a given substance.

A more detailed formulation will be necessary where in-stream processes and natural background loads are thought to be significant. The following formula is based on an approach established by OSPAR (2004b) for the calculation of diffuse nutrient loads; in-river nutrient processing is typically significant. The formulation is also applicable to the PS:

$$LDiff = Ly - Dp - LB + NP$$

Where, for a given contaminant, LB is the natural background load of the contaminant, and NP is the net outcome of in-river processes upstream of the monitoring point.

The riverine load approach provides a useful means of estimating diffuse inputs and/or validating modelled predictions. However, diffuse inputs from different sources are lumped into a single value and it is not possible, for example, to distinguish between inputs arising from agriculture and those from urban runoff.

IV.1.2. Pathway oriented approaches including hydrology-driven transfer processes

Pathway oriented approaches are well established and applied in many European RBDs for the quantification of nutrients and heavy metal inputs. Here, understanding the transformation, removal and temporal storage processes taking place between the source of emission and the receiving water body is vital.

As defined in chapter 2, inputs can be caused by point and diffuse sources. Accordingly, point source-pathways are defined by being discrete, having distinct locations and quasi-continuous discharge, e.g. the discharge of municipal waste water treatment plants and industrial plants. Diffuse source inputs influence different pathways and are discharged via different runoff components into surface waters. A differentiation of the runoff components is necessary as substance concentrations as well as the underlying processes may differ significantly for the considered substances.

The current state of knowledge in RPA identifies 13 potential pathways for inputs into surface waters. This is summarized in the general working scheme (cf figure 2). Not all potential pathways are important for all substances under consideration.

To keep track the pathways can be classified into three blocks:

1. pathways depend on point-source
2. pathways depend on diffuse non-urban sources and
3. pathways depend on diffuse urban sources.

The calculation of emissions from point sources can be straightforward, as data on effluent concentration and the amount of treated waste water are available or can be derived from statistical data with the required accuracy.

The inputs caused by diffuse sources are the result of more or less complex interactions with different interfaces, including temporal storage, transformation and losses. These processes have to be integrated into the approaches adequately.

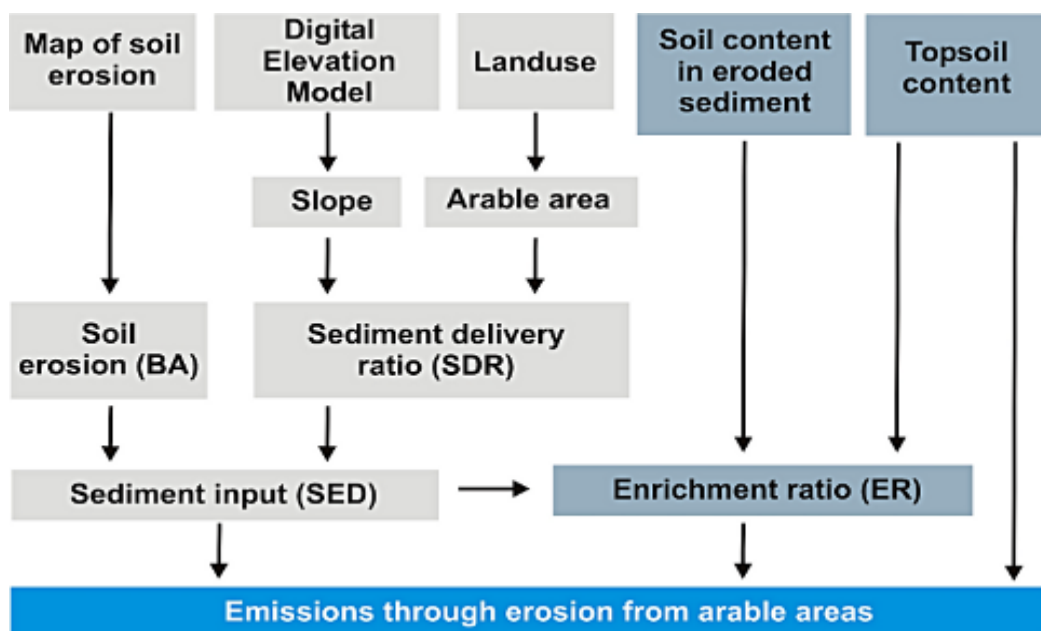

Figure 3: Input data to quantify the emissions from erosion (taken from Fuchs et al., 2010)

Pathways from agricultural diffuse sources include erosion, surface run off, tile drainage, seepage and spray drift. With regard to the transported masses and the complexity of processes involved, erosion is most suitable to illustrate the principles of pathway oriented approaches particularly as PS, including PPPs, can readily attach to soil and eroded sediment (see figure 3).

The initial process of pollutant inputs via erosion is the mobilization of top soil caused by heavy rainfall. At a river basin scale the soil loss from arable land is commonly calculated using an adapted version of the Universal Soil Loss Equation (Wischmeier, W. H., and D. D. Smith, 1960) which considers the slope, rainfall (energy input), soil characteristics, land cover and cultivation as well as active erosion protection measures. In the second step, the proportion of eroded soil entering the surface water is calculated (sediment delivery ratio). Based on a Geographical Information System (GIS)-supported sub model, individual areas within a catchment can be identified where eroded soil reaches a water body, enabling a relationship between sediment delivery and catchment characteristics to be obtained (Behrendt et al., 1999). The slope and the share of arable land have a large influence on the sediment input. During the erosion process, fine particles accumulate in the transported sediment. As pollutants are predominantly bound to finer grains, they also accumulate during the transport process. The enrichment of a substance in the erosion material is described by the enrichment ratio (EnR) which is the ratio between the substance concentration in the top soil and in the sediment reaching the water body. Beyond the initial substance concentration, the grain size distribution of the

top soil and the intensity of the classification process are the most important factors influencing the sediment concentration.

Storm sewers and combined overflows are important diffuse pathways in all urbanized parts of a river basin. Up to 40 % of the total heavy metal load or 25 % of the total PAH load emitted into surface waters can be traced back to storm sewer outlet and combined sewer overflows. These pathways account for various sources including air pollution, waste water from industries and households as well as primary emissions from construction material and traffic. For the calculation of annual pollutant loads emitted to surface waters several processes including mixing, transformation and retention, taking place on urban surfaces and within sewer systems, have to be taken into account. The relevance of these processes is highly variable and depends on local boundary conditions. In general a more complex situation can be assumed in combined sewer systems where it has to be considered that a certain portion of storm water is routed to a central waste water treatment plant and that the discharges via combined sewer overflow (CSO) include a variable amount of sewage.

The calculation of pollutant load discharged via storm sewers can be based on a regionalised and area specific surface load (e.g. Cu 204 g/(ha·a)) for any pollutant under consideration. This specific surface load is derived from observed runoff concentrations and precipitation data and it is assumed that it is realised every year independent of the inter-annual variation of precipitation. Regionalisation of specific surface loads can be based on three categories of intensity of urbanisation (rural, urban, urban agglomeration).

For combined sewer systems, the overflow rate and the proportion of discharged wastewater that is mixed up with the stormwater should be estimated. The overflow rate is strictly dependent on the storage volume realised in the catchment and the hydraulic capacity of the waste water treatment plant. For example on average, combined overflows may run for approximately 200 h/a (Brombach et al 1997) and for this time the related sewage load has to be added to the specific surface load.

As illustrated for erosion and urban sewer systems, pathway oriented approaches always require process studies and input data which allow for the formulation of empirical sub models. Due to the fact that these process studies may be limited, the identification of the necessary variables, in a way that enables wide application of such models, may prove challenging. Transfer of a model application from one river basin to another always needs a cross check of the sub-model used.

IV.1.3. Source oriented approaches (SFA, SOCOPSE project)

Substance Flow Analysis (SFA), a source oriented approach, is a method of analysing the flows of a substance in a well-defined system, including through industries producing and using it, households, wastewater treatment plants and all connected media such as soil, air and water.

All the applications and uses of a substance are collated, enabling strategies to reduce the impact of the substance to be developed. Such measures are not necessarily only end-of-pipe as in other approaches but can also encompass source controls such as product substitution. SFA is applied in connection with the early recognition of potentially harmful or beneficial accumulations and depletions in stocks, as well as the prediction of future environmental loads. SFA methods, as we know them today, were first applied by Wolman in the wake of the introducing metabolism studies for cities (Wolman, 1965).

Basic information on sources was collected during the drafting process of the EQS Directive and made available by the Commission (DG ENV, 2005).

In the SOCOPE project [www.socopse.se] for example, SFA is used to describe current European sources, fluxes, and endpoints in the environment for selected PSs. This information is used to identify important source categories and to set priorities for emission control measures. Information to construct SFAs can be derived from different sources such as: inventories of goods and their PS concentrations; statistical data on the use of PSs in different economic sectors and; concentration of PSs in raw materials and production data. In cases where data are not available, emission factors, release rates and other statistical information can be used for estimation.

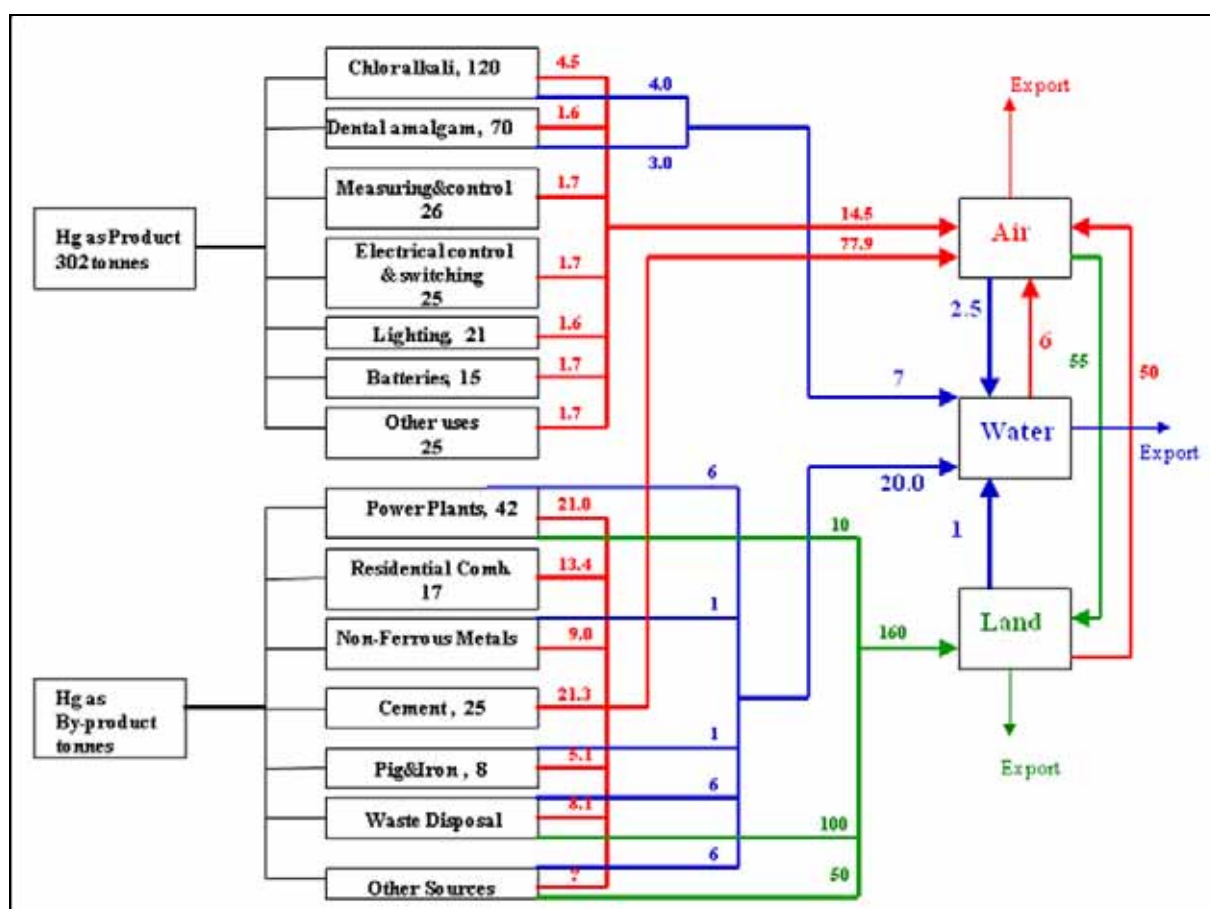

Figure 4: SFA for mercury in Europe in 2000 (numbers in tonnes/year)

Figure 4 shows an example of a SFA for mercury in Europe in 2000 from the SOCOPSE project (NILU, 2009). One advantage of the source-oriented approach is that, if all fluxes are known, it is possible to identify the most efficient emission reduction, because the SFA gives the share of the different emission sources to water, soil and air.

One drawback to SFA is that applicable data are often limited to specific spatial or temporary solutions, which influence the quality of the resulting SFA. Data sets are often only available on a country or EU level. If the perspective is limited to a river basin, proxies often have to be used to illustrate the regional situation. And even though national data may be of high quality because they were compiled accurately, downsizing to the regional level can incorporate errors. Particularly for PSs, use and emission figures can decrease steeply in the space of a few years, so that the corresponding emission factors become worthless. As a result, it is necessary for a SFA to cite information about the time and regional frame for each figure used.

IV.2. Input data needs for the different approaches: building blocks, using existing EU and international data sources

For the generation of an inventory, the EQS Directive requires the use of data obtained by implementing Articles 5 and 8 of Directive 2000/60/EC, Regulation (EC) No 166/2006 and from other available sources. The different data management systems can be operated on regional, national or international level.

Besides the data management systems based on EU-legislation, other data sources can be available from other legal national and international dataflows or based on voluntary data management systems.

Many data are generated for reasons other than fulfilling reporting obligations. For the compilation of an emissions inventory it is of crucial importance that the data are quality checked.

Special attention should be given to the identity of the chemicals concerned as discrepancies can exist between the reporting obligations. Normally for an inventory it is the total emissions of a substance / group of substances that matter, not the species which is used to assess the status, as speciation varies over time.

For example, Annex X of the WFD names brominated diphenylethers as priority substances but sets EQS only for six congeners of pentabromodiphenylether. The E-PRTR however requests emissions data for the sum of penta-, octa- and deca-BDEs. So the E-PRTR data can be used to compile the inventory of brominated diphenylethers, but cannot provide specific information about the congeners.

In the following an overview of possible data sources is provided. In Table 3 the use of data for the different assessment approaches is indicated. This indicative list of data sources should support the

generation of the inventory of emissions, discharges and losses. However many data are collected through different data streams and it is of utmost importance to avoid double counting. For that, information coming from different reporting streams should not be simply “joined” but have to go through a critical compilation process to identify data common to the different streams and those that are different.

IV.2.1. Legal data flows

The following legislatively based reporting obligations are the core sources for the data needed for the inventory on emissions, discharges and losses

- Reporting under the WFD (Art. 5 and 8)
- Reporting schemes under the Urban Waste Water Treatment Directive
- Reporting under the European Pollutant Release and Transfer Register (E-PRTR).
- Reporting under the Dangerous Substances Directive

IV.2.2. Voluntary data flows

There are several other dataflow organised by Eurostat/ Organisation for Economic Cooperation and Development (OECD) where the MS are co-operating to gather the information, to develop and apply common definitions and criteria for the quality control of the data, and to verify the data and to provide the information necessary to interpret and report the submitted data.

Further, detailed reporting exercises are organized by the Contracting Parties within the frame of the existing international conventions such as Danube River Protection Convention (DRPC), OSPAR Convention, and the Helsinki Convention on the Protection of the Marine Environment of the Baltic Sea Area (HELCOM) and Stockholm Convention on Persistent Organic Pollutants (POP).

IV.2.3. WISE

The development and the update of the Water Information System for Europe (WISE) have been triggered by the need to streamline and facilitate reporting from the MS to the Commission and to improve its effectiveness. Many reporting obligations are integrated into WISE covering also other water-related Directives, in particular the UWWTD, Bathing Water Directive (BWD), Nitrate Directive (NiD), Drinking Water Directive (DWD) and other mandatory or voluntary reporting to the EU level, in particular submissions to the European Environment Agency (EEA) and EUROSTAT (see Figure 5 below).

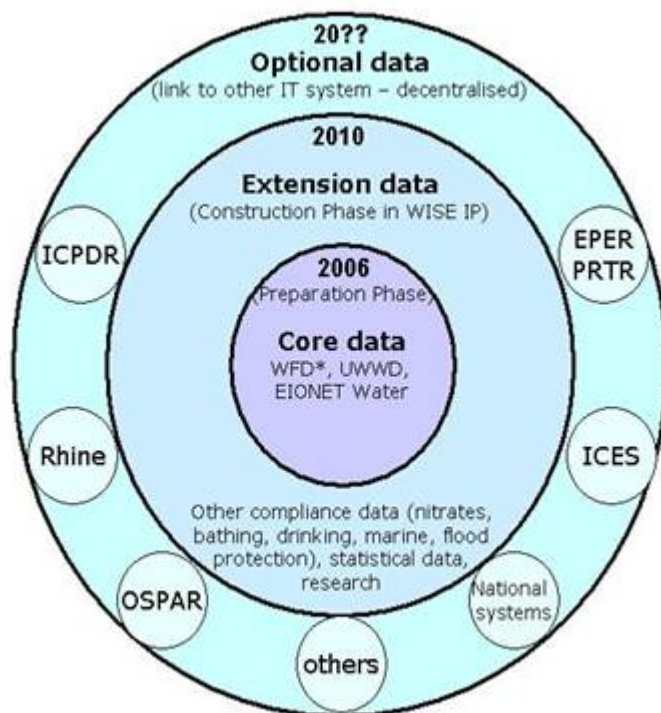

* includes all WFD compliance data - Art. 3, 5, 8, 13 and intercalibration

Figure 5: Concept of the Water Information System for Europe (WISE)

The Eurostat/OECD Water Statistics Joint Questionnaire on Inland Water provides national aggregates for load generation and inputs by sector – however data coverage is very poor (in particular for heavy metals and specific organic PS are not included)⁸. It is considered useful for comparison of national estimates for a few pollutants but not a feasible dataflow for the WFD / EQS emission inventory.

State of the Environment (SoE) inputs aim at collecting existing national inventories at RDB aggregation level and are potentially an important dataflow: <http://rod.eionet.europa.eu/obligations/632>. Data from the 1st year of reporting have been published: <http://www.eea.europa.eu/data-and-maps/data/waterbase-emissions>, and some compilation documents prepared by the European Topic Centre for Water (ETC/W) are available.

IV.2.4. Additional national/regional dataflows

Additional data sources which may be used for the compilation of the emission inventory are national or regional data management systems (based on legal obligations, for management purposes, for statistical duties, for subsidies or for other reasons), environmental reports or scientific data. These data can have different restrictions in spatial scale, time, coverage, availability or aggregation which have to be considered for their usage for the emission inventory. In the various MS the situation may be different, with more or other data being available from different sources. This chapter contains

⁸ <http://appsso.eurostat.ec.europa.eu/nui/setupModifyTableLayout.do>

many types of data but due to the different approaches and situations in the MS it cannot be completely comprehensive.

Examples of types and sources of data:

- Permit data
- Wastewater and emission monitoring data
- Water quality monitoring data
- Statistical data (inhabitants, connection rates to sewer systems, tourism data, ...)
- Wastewater charges
- Subsidies data on investment and operation of water and wastewater facilities
- Case studies / research data
- Environmental reports
- Other data:
 - o hydrological data
 - o soil data
 - o (hydro-) geological data
 - o production data
 - o import/export data
 - o deposition data
 - o agricultural data
 - o substance application data

Table 3: Data sources with indication to the different estimation approaches

| | Data flow / source | Point Source data | Riverine load approach | Pathway oriented approach | Source orientated approach |
|--------------------------------|---|-------------------|------------------------|---------------------------|----------------------------|
| EU-Legislation | 2000/60/EC - WFD: Article 5 and 8 | x | x | x | |
| EU-Legislation | Regulation (EC) No. 166/2006 - E-PRTR | x | | x | |
| EU-Legislation | 91/271/EEC - Urban Wastewater Treatment Directive | x | | x | |
| EU-Legislation | 2006/11/EC - Dangerous Substances Directive | x | | x | |
| EU-Legislation | EC 1907/2006 - REACH | | | | x |
| International data collections | POP-Convention | | | | x |
| International data collections | SoE Dataflow | x | x | x | |

| | Data flow / source | Point Source data | Riverine load approach | Pathway oriented approach | Source orientated approach |
|--------------------------------|--|-------------------|------------------------|---------------------------|----------------------------|
| International data collections | OSPAR | x | x | x | |
| International data collections | HELCOM | x | x | x | |
| International data collections | International River Commissions (Danube, Rhine, Elbe, ...) | x | x | x | |
| International data collections | OECD/EUROSTAT Joint Questionnaire on Inland Waters | x | | x | |
| National/regional data | Permits | x | x | x | |
| National/regional data | Waste water and emissions monitoring data | x | x | x | |
| National/regional data | Water quality monitoring data | | x | x | |
| Statistical data | inhabitants, connection rates to sewer systems, tourism, agricultural data, production data, export/import data,... | x | | x | x |
| Spatial / physical data | Hydrological data, soil data, (hydro-) geological data, land use (e.g. CORINE Land Cover), deposition data (e.g. EMEP), substance application data,... | | | x | |

IV.3. Proposed procedure for the compilation of the inventory

As the compilation of the inventory is a demanding task which blends the information from various sources in a structured way, an iterative approach is necessary, which also reflects longer term objectives. Due to data gaps as well lack of time, resources and funds it might not be possible to obtain the results preferred from the water management perspective in the first run, and it might therefore be an option to include tasks to improve the inventory (moving to a higher tier analysis) in the next RBMP.

Based on the discussions in chapters I. 3 and III. 1- III. 4 the following steps are recommended when planning and compiling the inventory:

1. Identification of the “relevant” substances for the RBD

The criteria developed in chapter I 3 are related either to the monitoring results of the last years or the compilation of known pressures and emissions. So this information has to be collected and compiled. As a result of this selection process a list of substances relevant for the RBD concerned is available. MS may opt for certain substances identified in one RBD also to include them in the inventories for other RBDs in their territory with the aim of compiling a national overview.

2. Identification of the information outputs required from the inventory / preliminary method selection (substance specific)

A European-wide estimate of point and diffuse substance inputs can be achieved with the methodologies proposed for the minimum expectations.

As the different methodologies however provide different levels of detail in the results, it is recommended as a second step to identify the information needs for the next RBMP tasks. So for example, when it is likely that the proportion of diffuse inputs is high in the RBD and targeted measures, especially in hot-spots, to reduce these inputs have to be implemented, additional information on location and share of different pathways is required. In such a case, the information which can be extracted from the riverine load approach is normally not sufficient. The information on the share of different diffuse pathways and a spatial resolution to identify hot spots however can be extracted from RPA compilations. For an overview of the information which can be extracted from the different methodologies refer to Table 2. On the basis of the identified needs a substance-specific preliminary method selection should be performed.

3. Survey of available information needed for the selected tiers

The next step is to compile the information needed for the selected tiers and to check which part of it is available and can be utilised. Important data sources are described in chapter IV 2.

- Point source data can be taken from the E-PRTR system. However, evaluations of the E-PRTR indicate that it may cover only part of the relevant point source emissions. Especially low-concentration inputs from UWWTPs, together with the high volume of waste water from the urban sector, might lead to additional inputs which have to be accounted for. A combined evaluation of the substance invariant information of the UWWT Directive-reporting (size, location, technology and waste water volume) and the use of emission factors may give reasonable estimates. However the derivation of the emission factors requires high-quality concentration measurements and a careful evaluation of these results. This is an area where close cooperation between MS and scientific institutions may be useful.

- The application of the riverine load approach requires data on discharges and on average concentrations of the substances in whole water if available (in the dissolved phase and in suspended solids). This information should be available in the quality required by the Commission Directive 2009/90/EC for most substances at least at the confluence of the most important tributaries and on “border” monitoring stations. For heavy metals a problem could arise from the fact that, unlike for the organic substances, the samples have to be filtered. This may cause a significant underestimation of the transported loads.
- Pathway oriented approaches (e.g. RPA) require:
 - Substance invariant regionalized data on topology, geology, land use etc which can be taken from various maps or statistical sources. If for a RBD an RPA for nutrients already exists (e.g. a MONERIS Analysis) this is a good starting point as it already covers a great portion of the required substance invariant information.
 - Substance-specific concentrations (if possible also regionalised) at the various transfer points are required. A joint compilation of results available in several MS might help.

Source oriented approaches require data on production, consumption use and emission into different environmental media; which might be available from chemical management institutions as well as infrastructure and other statistical data. Furthermore, information on storage and transfer processes in the environment is required. Here, data collected by the authorities for the management of chemicals, PPPs or biocides, national inventories and also international information, e.g. from different OECD activities, are valuable sources of information.

4. Identification of data gaps for the selected tiers and assessment of efforts needed to close the identified data gaps

As a result of Step 3 and the data requirements for the preliminary selected tiers the data gaps will become obvious. It should be also identified which parts of the intended investigations are hampered by the missing data. If the affected parts of the input inventory only affects parts which are very likely to be of minor relevance simpler substitutes for this part can be considered.

Based on these assessments the efforts needed to close the identified data gaps or to provide the substitutes can be assessed.

5. Final decision on method selection (substance-specific) for the current inventory compilation

Steps 2-4 will form the basis for the final selection of the approaches which should be taken for the current inventory compilation. It will become clear which information required from the inventory for the next RBMP tasks will not be available from the first compilation. International coordination / exchange of experiences in an international RBD should be also part this process .

6. Formulation of tasks for the next RBMP (substance-specific), if improvements necessary in the inventory, e.g. by use of higher-tier approaches

The data gaps and investigations needed to improve future inventories should be known. The investigations should be included in the next RBMP. This step ensures that the information identified in Step 2 will be available by the time the next inventory is compiled.

7. Preparation, check and refinement of the substance-specific inventories

Finally the different approaches should be compiled and checked against each other. This cross-checking, especially against the riverine load approach, provides indications of the completeness and the plausibility of results. At the right spatial scale, source and pathway specific investigations can be compared.

8. Presentation of the results

The results can be presented in tables or graphs as well as in maps showing either monitored loads or area / population-specific inputs into surface waters. Information on uncertainties and estimates of errors should be also provided. Key conclusions for water-management purposes, i.e. the proportion of point and diffuse sources, identification of important sources / pathways and thus possible targets for reduction measures should be integrated into the RBMP.

Specific MS examples are given in the annexes of this guidance document.

A reporting sheet for the inventory, aiming at providing information for a pan-European overview is being developed.

IV.4. Interpretation of the results from the different approaches

IV.4.1 Interpretation

As indicated in Table 2 the different approaches provide results at a different level of detail. Furthermore the results are available at different regional scales, based on methodology and regional differentiation of input data / coefficients.

1. Point source emissions

These localised emissions are in general reliable; however they should be checked

- if analytical results used for the load calculation show a high percentage of measurements below LOD / LOQ. This may lead to a clear over- or underestimation of those inputs, depending on how these results are taken into account.
- if emission values resulting from the use of emission factors are derived for the installations concerned. Use of emission factors reduces the spatial resolution and may lead to over- or underestimation of emissions from specific installations, although the average for several installations may be correct.

2. Riverine load approach

These results are in summary the loads of all upstream inputs plus the net sum of loads transported from and to internal stores. Depending on the flow conditions this transport may increase or decrease the monitored loads, therefore the result should be corrected for these in-stream processes. The net difference between the observed loads and the point source emissions serves as a basic estimate of all diffuse inputs.

3. Pathway oriented approach

Pathway oriented methods, when they are adapted to the situation in the RBD district, give inputs separated into different pathways regionalised into a network of small, hydrologically connected catchments. So, in addition to the localised point source emissions also localised information on diffuse inputs is available. This allows also for the identification of hot spots.

4. Source oriented approach

Here the data depend strongly on how the underlying model covers the actual situation in the river basin. As most of the production and use data are only available at national / EU level the derivation of regional information is a comprehensive task.

The source oriented method gives information on the contribution of certain sources to the pathway specific loads, however disaggregation is difficult (see Chapter III 2).

IV.4.2 Comparison

Inter-method comparison of the results at the MS level gives valuable information on the plausibility of results.

As point source information and in-stream loads are determined by measurements they are relatively reliable and serve as reference points in the comparisons.

The results of load estimations should normally be higher than the point source emissions. If not this indicates the existence of high internal storage / degradation processes which have to be taken into account, otherwise the estimated diffuse inputs would be significantly too low.

RPA estimations are normally fitted / compared to the loads transported through a high number of gauges / monitoring stations to try to minimize the overall error which normally is within $\pm 30\%$ range for the individual stations. As an example a comparison of observed vs. monitored load for Nickel in Germany is given in Figure 6.

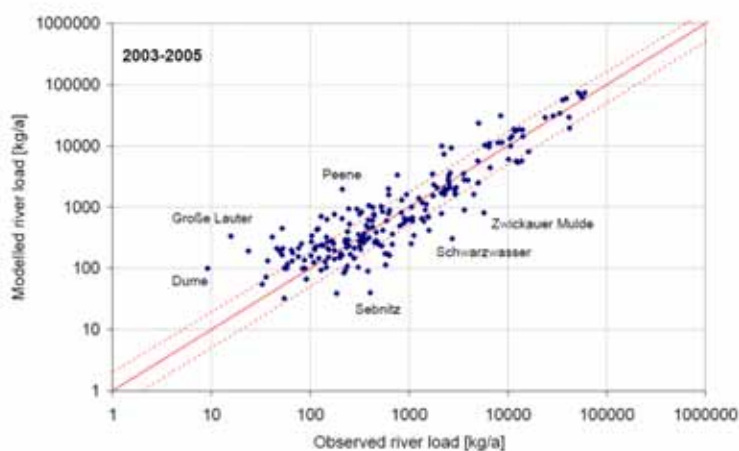
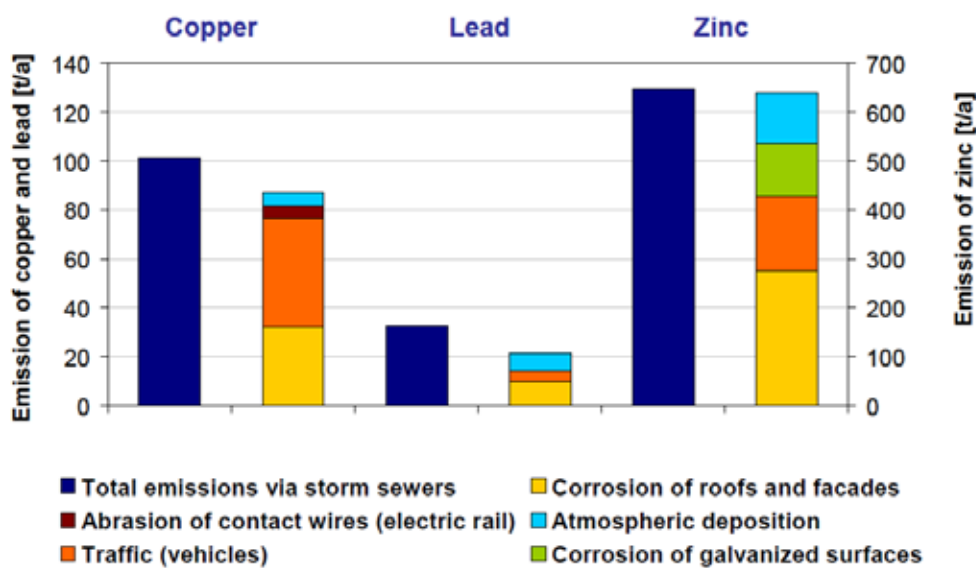

Figure 6: Comparison of calculated and observed loads of nickel using RPA for Germany (Fuchs et al. 2010)

Source based disaggregations can also be compared to the riverine loads.

A comparison of source oriented / pathway oriented results is also possible if the data situation is good and the spatial aggregation level is adequate. Figure 7 shows the comparison between a source specific emission estimation and a pathway specific estimation for the emissions via storm sewers for copper, zinc and lead for the Federal Republic of Germany. Here both results match quite well (figure taken from Fuchs et. al 2010).



Comparison of the calculated emissions from storm sewers for copper, lead and zinc with the source-specific emission approach according to HILLEN-BRAND ET AL. (2005)

Figure 7: Comparison of the calculated emissions from storm sewers for copper, lead and zinc with the source-specific emission approach according to Hillen-Brand et al. (2005)

IV.4.3 Use of results in water management processes

As the objectives of the inventories for river basin management have been defined in the proposed procedure, the results obtained should be compared with the objectives. As mentioned previously, a higher tier approach may be needed for future inventories to improve their usefulness in water management.

If measures for hot spots are planned on the basis of the inventory results, an additional round of plausibility checking should be performed to ensure that the measures are applied at a scale corresponding to the scale of the problem, which could be the result of very specific local conditions not evident from the geographical scale of the inventory.

REFERENCES

Behrendt, H.; Huber, P.; Opitz, D.; Schmoll, O.; Scholz, G.; Uebe, R. (1999): Nährstoffbilanzierung der Flussgebiete Deutschlands. UBA-Texte 75/99, Berlin.

Brombach, HJ.; Wöhrle, Ch. (1997): Gemessene Entlastungsaktivität von Regenüberlaufbecken. Korrespondenz Abwasser, 44, S. 44-66.

DG ENV, 2005, "Informal Background document related to the Commission documents on priority substances (COM (2006) 397 FINAL and COM (2006) 398 FINAL)" Source identification and emission controls: Concept paper on the control of emissions, discharges and losses of priority substances and priority hazardous substances in the framework of article 16 of Directive 2000/60/EC (Water Framework Directive)" http://circa.europa.eu/Members/irc/env/wfd/library?l=/working_groups/priority_substances/drafting_emissions/background_documents/eg_on_emissions/identification_controls/ EN_1.0_&a=d

Fuchs, S., Scherer, U., Wander, R., Behrendt, H., Venohr, M., Opitz, D., Hillenbrand, Th., Marscheider-Weidemann, F., Götz, Th. (2010): Calculation of Emissions into Rivers in Germany using the MONERIS Model. Nutrients, heavy metals and polycyclic aromatic hydrocarbons. UBA-Texte 46/2010, Dessau

NILU, 2009. Material Flow Analysis for selected Priority Substances, FP6 project SOCOPSE, Deliverable D.2.1, p. 74

OSPAR (2004a) HARP-NUT "Guideline 7: Quantification and reporting of the monitored riverine load of nitrogen and phosphorus, including flow normalisation procedures." Reference Number: 2004-2. http://www.ospar.org/documents/dbase/decrecs/agreements/04-02g_HARPNUT%20guideline%207_monitored%20riverine%20load.doc

OSPAR (2004b). OSPAR Guidelines for Harmonised Quantification and Reporting Procedures for Nutrients (HARP-NUT). Reference number: 2004-2. Guideline 8: Quantification of nitrogen and phosphorus losses from diffuse sources by riverine load apportionment. http://www.ospar.org/documents/dbase/decrecs/agreements/04-02h_HARPNUT%20guideline%208_diffuse%20sources.doc

Schwertmann, U., W. Vogl & M. Kainz (1987): Bodenerosion durch Wasser – Vorhersage des Abtrags und Bewertung von Gegenmaßnahmen. – Ulmer Verlag, 64 S.

Stranddorf, HK, Hoffmann L, Schmidt A (2005). Update on Impact Categories, Normalisation and Weighting in LCA – Selected EDIP97 data. Environmental Project No. 995 2005. The Danish Environmental Protection Agency. <http://www2.mst.dk/Udgiv/publications/2005/87-7614-570-0/pdf/87-7614-571-9.pdf>

Wischmeier, W. H., and D. D. Smith, 1960. "A universal soil-loss equation to guide conservation farm planning." Trans. Int. Congr. Soil Sci., 7th, p. 418-425

Wolman, A: The metabolism of cities. Scientific American (1965), 213(3);, 179-190.

GLOSSARY

| | |
|--------|---|
| BWD | Bathing Water Directive |
| DG | Drafting Group |
| DRPC | Danube River Protection Convention |
| DSD | Dangerous Substances Directive |
| EC | European Commission |
| EEA | European Environment Agency |
| E-PRTR | European-Pollutant Release and Transfer Register |
| EQS | Environmental Quality Standard |
| ETC/W | European Topic Centre for Water |
| GIS | Geographical Information System |
| HELCOM | Helsinki Commission for the Protection of the Marine Environment of the Baltic Sea |
| ICES | International Council for the Exploration of the Sea |
| IPPC | Integrated Pollution Prevention and Control |
| LCA | Life Cycle Assessment |
| MS | Member State |
| NiD | Nitrate Directive |
| OECD | Organisation for Economic Cooperation and Development |
| OSPAR | OSlo-PARis (Convention for the Protection of Marine Environment of the North-East Atlantic) |
| PHS | Priority Hazardous Substance |
| PoM | Programme of Measures |
| POP | Persistent Organic Pollutant |
| PPP | Plant Protection Products |
| PS | Priority Substance |
| RBD | River Basin District |
| RBMP | River Basin Management Plan |
| RPA | Regionalised Pathway Analysis |
| SCG | Strategic Coordination Group |
| SCHER | Scientific Committee on Health and Environmental Risks |
| SFA | Substance Flow Analysis |
| SOA | Source Oriented Approach |
| SoE | State of the Environment |
| UWWTP | Urban Waste Water Treatment Plant |
| WFD | Water Framework Directive |
| WG E | Working Group E |
| WISE | Water Information System for Europe |

PREPARATION OF THE GUIDANCE

Mandate for the Drafting Group

This Guidance Document was prepared under the WFD Common Implementation Strategy (CIS) by the Drafting Group (DG) on PS inventory set up in 2010 according to a mandate agreed by the Water Directors at their meeting on 27-28 May 2010 in Segovia.

The DG worked under the umbrella of the CIS Working Group E on Chemical Aspects and was co-led by Germany (Joachim Heidemeier), France (Lauriane Greaud) and DG ENV (Madalina David).

List of participants in the Drafting Group

| Name | Member State/Organisation |
|-----------------------------|---|
| Joachim Heidemeier | Federal Environment Agency, DE |
| Stephan Fuchs | Karlsruhe Institute of Technology, DE Consultant |
| Frank Marscheider-Weidemann | Fraunhofer Institute, DE Consultant |
| Lauriane Greaud | Ministère de l'écologie, FR |
| Aurelien Gouzy | Ineris, FR Consultant |
| Madalina David | DG ENV, DI |
| Benoît Fribourg-Blanc | IOW, Commission's Consultant |
| Robert Peter Collins | European Environmental Agency |
| Bo Jacobsen | European Environmental Agency |
| Joost van de Roovaart | Deltares Institute (NL) |
| Greet Vos | Flemish Environment Agency |
| Georg Windhofer | Environment Agency, AT |
| Ester Ortega Busutil | Ministerio de Medio Ambiente, y Medio Rural y Marino, IT |
| Mezzina Leo | Italian Ministry of the Environment |
| Giordano Giorgi | ISPRA, Italian Environmental Agency |
| John Batty | DEFRA, UK |
| Mihaela Popovici | ICPDR, Pressures and Measures Expert Group |
| Klaas den Haan | CONCAWE |
| Albert Willemsen | NAVI TG - ICOMIA |
| Jan Brooke | NAVI TG - ESPO |
| Thierry Schoonejans | ECPA - Dow AgroSciences |
| Andrea Stoegbauer | CEFIC |

ANNEXES: COUNTRY EXAMPLES

Austria case study fact sheet

General information

country: *Austria*

title of the project/study:

Emissions of organic and inorganic micro pollutants from Austrian urban wastewater treatment plants

type: *Case Study*

The Project was worked out for preparatory purposes for a national legal document (ordinance) about an emission register for surface waters.

scope:

- Information gathering: Up to this project only little information in Austria was available about organic and inorganic micro pollutants discharged from urban wastewater treatment plants.
- Selection of present priority and other Substances of national concern

duration: *2007 – 2009*

status: *finalized*

methodology used :

- Analytical analysis of influents and effluents of selected 15 Austrian urban wastewater treatment plants as a first step of the project defining the substances for an in deep assessment in a second step
- Analysis of effluents of 9 Austrian urban wastewater treatment plant 5 times over a one year period on selected substances (result of step 1)
- Assessment of the fate of substance during wastewater treatment in two urban wastewater treatment plant with mass balance over a 2 week period.

information resources (URL):

The final report of the project is available in German language under <http://www.umweltbundesamt.at/fileadmin/site/publikationen/REP0247.pdf>

contact person/organisation:

Environment Agency Austria:

Dr. Manfred CLARA (Manfred.clara@umweltbundesamt.at)

Georg Windhofer (Georg.windhofer@umweltbundesamt.at)

Abstract

INTRODUCTION

The focus on substances in urban wastewater management developed in the last decades from organic pollutants (BOD₅, COD) to nutrients (nitrogen and phosphorus) and within the last years to micropollutants. In the European water policy the relevance of hazardous substances is reflected by the priority (PS) and priority hazardous substances (PHS) in the Water Framework Directive (WFD) (EC, 2000). The knowledge on occurrence and fate of xenobiotics in wastewater has increased in recent years.

The development of a national emission register for surface water from significant point sources (EMREG-SW) (BGBl. II 29/2009) has been already started with the WFD implementation process in Austria. In preparation of the legal basis for this EMREG-SW a comprehensive study was carried out in the years 2007 – 2009 on Austrian urban wastewater treatment plants (UWWTP), with the aim to identify relevant substances and substance groups, which should be monitored regularly in treated urban wastewaters.

METHODOLOGY

Selection of wastewater treatment plants

In a first step the UWWTPs to be sampled had to be selected. The 638 municipal UWWTP with a treatment capacity of more than 2000 population equivalents (pe) (Überreiter et al., 2010) were categorised dependent on their size and the industrial influence. The size was selected as categorisation criteria, because different requirements regarding the treatment efficiency exist for UWWTPs with treatment capacities of less or more than 5000 pe. According to Austrian legislation UWWTPs with a capacity of more than 5000 pe have to remove nitrogen and phosphorus, whereas UWWTPs below 5000 pe have to remove phosphorus and to apply nitrification. A second size class included UWWTPs with a treatment capacity of more than 150,000 pe as these large UWWTP are treating approx 50% of the total generated load (Überreiter et al., 2010).

The second categorisation criteria was the industrial contribution to the generated load. The industrial contribution was determined based on BOD and COD data. For 420 of the 638 UWWTPs data on BOD and/or COD influent load as well as information on the connected population was available. Based on specific discharges to wastewater of 60 g BOD/(cap□d) and 110 g COD/(cap□d) the industrial/commercial contribution to the UWWTP was calculated. Based on these calculation 3 different categories were defined. Category 1 included UWWTPs with industrial/commercial contribution (in terms of BOD and or COD) of less than 25%, which are considered as domestic areas with negligible industrial influence.

The most important categories in terms of generated load are those with an industrial/commercial contribution between 25 and 75% and a treatment capacity of more than 5000 pe. For a first assessment (module 1) 15 UWWTPs were selected out of the 6 categories by considering also different treatments technologies. For this first assessment influent and effluent samples were taken.

In a second step (module 2) the substances identified as potentially relevant were monitored over one year in 9 UWWTP effluents with a 2 months frequency. Additionally 2 UWWTPs were sampled over 2 weeks in order to assess the fate of selected compounds during the treatment. For this assessment influent, effluent and sludge samples were considered.

Applied relevance criteria

The aim of the first screening of 15 UWWTP effluents was to identify substances, for which the emission to the surface waters via wastewater discharges might be relevant and to select the compounds to be subjected to a further monitoring. All substances were excluded i) which were not detectable in none of the analysed effluent samples or ii) for which the maximum measured concentration was below half the EQS. The limited number of samples and the related uncertainty should at least partially be addressed by setting the relevance criteria with half the EQS and the comparison with the maximum measured concentration.

All substances which could not be excluded in the first step were subjected to a monitoring over one year. 9 UWWTPs effluents were sampled every two months. Based on the results of this monitoring those substances are considered as relevant in wastewaters for which i) the mean concentration of all measurements (including also those from the first step) was higher than half the EQS and ii) the average concentration in at least one of the sampled UWWTPs (only second step) is higher than the EQS. The second criterion is applicable only to the substances subjected to the annual monitoring.

RESULTS AND DISCUSSION

Results of the first screening (Modul 1)

The results of the screening of UWWTP influents and effluents (Modul 1) are summarized in table 1.

Table 1: Results of the screening on the occurrence of selected xenobiotics in treated and untreated wastewater.

| | Priority Substances, Priority Hazardous Substances and EU-wide regulated substances | Other substances |
|---|---|---|
| Not detected in influent and effluent | alachlor, chlorfenvinphos, endosulfane, hexachlorobenzene, hexachlorobutadiene, pentachlorophenol, pentachlorobenzene, trichlorbenzenes trifluralin, aldrin, dieldrin, endrin, isodrin, DDT, p'p'-DDT, tetrachloroethylene, tetrachloromethane, trichloroethylene | benzidine, chlordane, 1,2-dichloroethene, 2,5-dichlorophenole, 1,3-dichloro-2-propanole, heptachlor, mevinphos, omethoate, pentachloronitrobenzene, sebuthylazine |
| Detected in at least one influent sample but not in effluents | anthracene, 1,2-dichloroethane, naphthalene, fluoranthene, benzo(a)pyrene, benzo(b)fluoranthene, benzo(k)fluoranthene | cyanides (easily purgeable), dimethylamine, ethylbenzene, isopropylbenzene, linear alkylbenzene sulfonates, xylene |
| Maximum effluent concentration below EQS/2 | Atrazine, benzene, isoproturon, simazine, C ₁₀₋₁₃ chloroalkanes, lead* | benzylchloride, bisphenol-A, dibutyltin compounds, 2,4-dichlorophenole, phosalone, arsenic |
| Maximum effluent concentration above EQS/2 | Pentabrominated diphenyl ethers, cadmium*, chlorpyrifos, di(2-ethylhexyl)-phthalate, diuron, mercury*, nonylphenole, nickel*, octylphenol, tributyltin compounds, indeno(1,2,3-cd)pyrene**, benzo(g,h,i)perylene**, | Ammonia**, adsorbable organic halogens, chloroacetic acid**, ethylenediaminetetraacetic acid, nitrilotriacetic acid, fluorides**, nitrite**, trichlorfon, copper, zinc, |

| | | |
|--|---------------------------------------|------------------|
| | trichloromethane**, dichloromethane** | silver, selenium |
|--|---------------------------------------|------------------|

*...total concentrations were determined

**...not considered in the monitoring

According to the criteria mentioned before, the following substances were selected to be monitored in module 2 of the project over one year in two months intervals in the effluent of 9 UWWTPs: Pentabrominated diphenyl ethers, cadmium, chlorpyrifos, di(2-ethylhexyl)-phthalate, diuron, mercury, nonylphenole, nickel, octylphenol, tributyltin compounds, adsorbable organic halogens, ethylenediaminetetraacetic acid, nitrilotriacetic acid, trichlorfon, copper, zinc, selenium, sebuthylazine.

Monitoring xenobiotics in UWWTP effluents (Modul 2)

The screening (Modul 1) was performed in September, which might be beyond the application period of most Plant Protection Products (PPP). Beside the above mentioned substances PPP were measured again twice in May and in July/August (n=18) in order to confirm the observations and conclusions from the screening. The mean values of the investigated plant protection products are clearly below half the EQS and also the measured maximum concentrations are well below the EQS wherefore emissions from UWWTPs are deemed not as relevant sources for surface water contamination and are therefore not suggested to be regularly monitored.

The results of the Monitoring programme are summarized in Table 2.

Table 2: summary on the measured effluent concentrations (n=60)

| | Mean [µg/l] | Median [µg/l] | Min [µg/l] | Max [µg/l] |
|-----------------------|----------------|------------------|---------------|---------------|
| PBDE | 0,00021 | 0,000039 | n.d. | 0,0037 |
| cadmium | 0,056 | 0,010 | n.d. | 0,20 |
| DEHP | 0,51 | 0,22 | n.d. | 6,6 |
| diuron | 0,073 | 0,040 | n.d. | 0,65 |
| nonylphenole | 0,25 | 0,18 | n.d. | 1,8 |
| AOX | 110 | 43 | 2 | 3300 |
| EDTA | 65 | 43 | 6,5 | 310 |
| NTA | 45 | 12 | n.d. | 410 |
| Copper | 7,2 | 4,3 | 1,3 | 56 |
| Selenium | 2,3 | 0,30 | n.d. | 32 |
| Zinc | 32 | 31 | 3,0 | 72 |
| nickel | 5,6 | 4,1 | 1,0 | 41 |
| tributyltin compounds | 0,00020 | 0,00010 | n.d. | 0,0020 |

n.d. ... not detected

As described before mean values for each compound and UWWTP were determined and compared with the respective EQS (Fig. 1a). Beside cadmium, DEHP and nickel in at least one of the nine sampled UWWTPs the calculated mean effluent concentration exceeds the respective EQS. The mean concentration from all available effluent measurements (n=60 for each substance) exceeds half the EQS for all compounds beside DEHP, nickel and diuron (Fig. 1b). Hence comparable results are obtained by the application of the 2 criteria. For PBDE, nonylphenoles, diuron, tributyltin compounds, cadmium, AOX, EDTA, NTA, copper, selenium and zinc the impact on surface water quality via the discharge of treated wastewater might be of relevance and those substances are suggested for a regular monitoring.

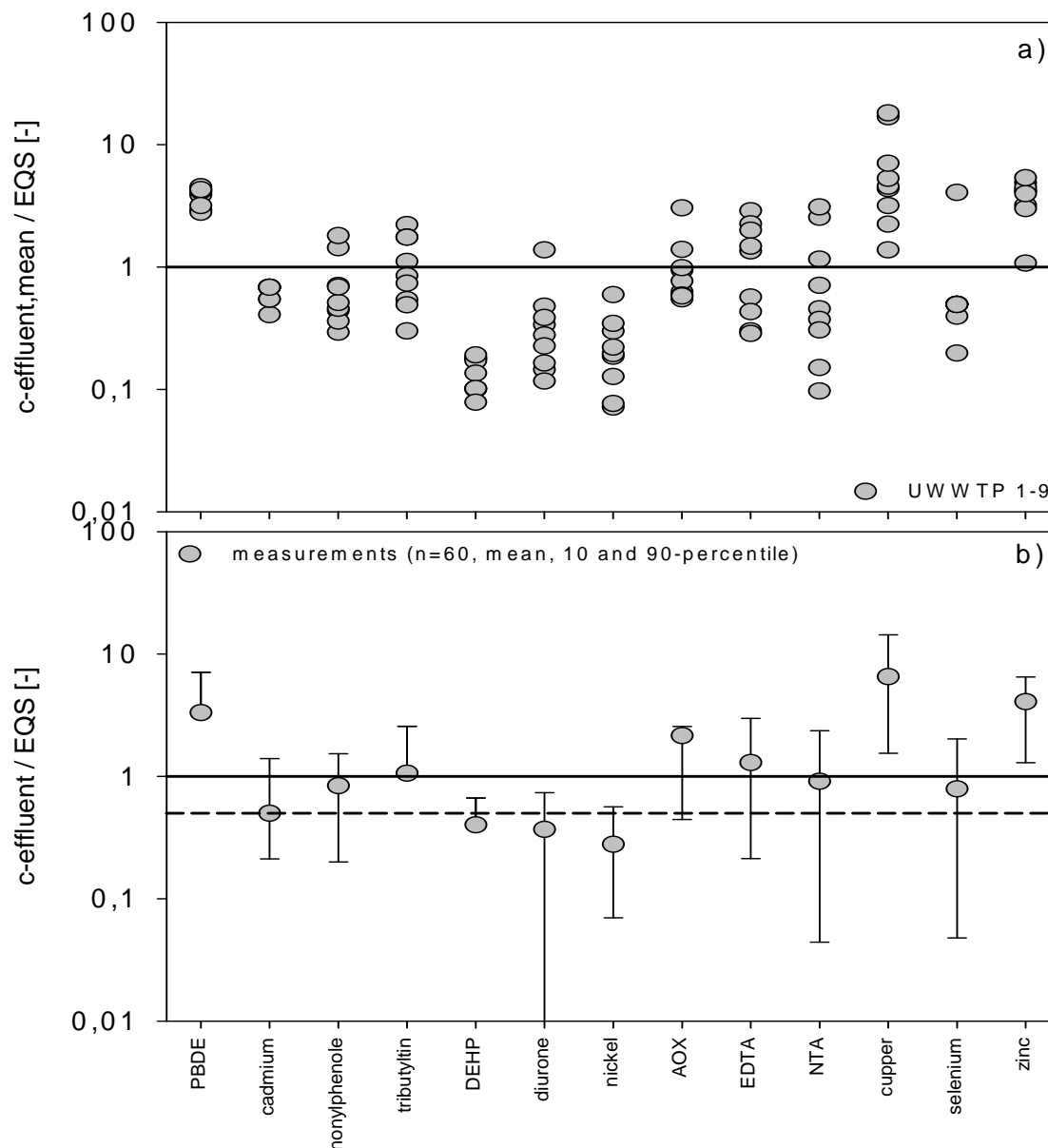

Figure 1: Ratio of mean values of each UWWTP to respective EQS (Fig. 1a); mean value of all effluent measurements compared against EQS and EQS/2 (Fig. 1b)

More details and results are available in the study report. (UBA, 2009).

CONCLUSION

As result of this study the priority substances diuron, cadmium, nonylphenole and tributyltin compounds were selected as relevant for UWWTP effluents for consideration in the Austrian EMREG-SW. Therefore these substances are included in this reporting scheme. UWWTPs with a design capacity above 10.000 pe have to measure these compounds within a six years reporting cycle at least 12 times over one year and report the annual loads in kg/a. For the relevant non priority substances there is no obligation for measurement. For UWWTP above 100.000 pe the annual emitted load can be estimated or calculated with emission factors and reported.

REFERENCES

EC (2000) Directive 2000/60/EC of the European Parliament and of the Council of 23 October 2000 establishing a framework for Community action in the field of water policy. Official Journal of the European Communities, L327/1, 22.12.2000. <http://eur-lex.europa.eu/LexUriServ/LexUriServ.do?uri=OJ:L:2000:327:0001:0072:EN:PDF>

BGBl. II 29/2009: Austrian ordinance for the emission register for surface waters (EMREG-SW), 29 January 2009
http://www.ris.bka.gv.at/Dokument.wxe?Abfrage=BgblAuth&Dokumentnummer=BGBLA_2009_II_29&ResultFunctionToken=0c677fea-33dc-4ab4-832c-102d643c4358&Position=1&Titel=&Bgblnummer=&SucheNachGesetzen=False&SucheNachKundmachungen=False&SucheNachVerordnungen=False&SucheNachSonstiges=False&SucheNachTeil1=False&SucheNachTeil2=False&SucheNachTeil3=False&VonDatum=01.01.2004&BisDatum=10.05.2011&ImRisSeit=Undefined&ResultPageSize=50&Suchworte=EMREG

Überreiter, E., Windhofer, G., Spira, Y., Zieritz, I. (2010) Kommunale Abwasserrichtlinie der EU - 91/271/EWG Österreichischer Bericht 2010 - Gemäß Artikel 16 der Richtlinie 91/271/EWG über die Behandlung von kommunalem Abwasser für den Zeitraum 2007 – 2008 (Austrian Report according to art. 16 UWWTD 91/271/EEC). Bundesministerium für Land- und Forstwirtschaft, Umwelt und Wasserwirtschaft, Vienna, June 2010. <http://www.wassernet.at/filemanager/download/67100/>.

UBA (2009) Emissionen organischer und anorganischer Stoffe aus kommunalen Kläranlagen, Umweltbundesamt, Vienna 2009
<http://www.umweltbundesamt.at/fileadmin/site/publikationen/REP0247.pdf>

Germany case study fact sheet I

country: Germany

title of the project/study: German Substance Flow Analysis of Priority Substances

type: research projects

scope: A bundle of different research projects carried out by Fraunhofer ISI for SFAs for the 33 priority substances and heavy metals to access sources, pathways and measures to reduce emissions.

duration: (start and end date): 2001 to 2007

status: ongoing

methodology used : substance flow analysis

information resources (URL): The final reports of the projects are available under <http://www.umweltdaten.de/publikationen/fpdf-l/3311.pdf> (report about Emissions reduction for priority and priority hazardous substances of the WFD; in English)

<http://www.umweltdaten.de/publikationen/fpdf-l/3312.pdf> (substance-specific data sheets for the 33 priority substances of the WFD; in German)

<http://www.umweltdaten.de/publikationen/fpdf-l/2936.pdf> (report about copper, zinc and lead; in German, summary in English)

contact person/organisation:

Fraunhofer ISI, Frank Marscheider-Weidemann (mw@isi.fraunhofer.de), Thomas Hillenbrand (hi@isi.fraunhofer.de)

Umweltbundesamt, Joachim Heidemeier (joachim.heidemeier@uba.de)

Abstract

The aim of the project series mentioned above was to analyse the emission situation of priority substances in Germany and to come up with suggestions for emission controls. The main focus was on the 33 substances of the WFD and additionally the heavy metals copper and zinc.

The method of SFA was applied to get information about the production, imports/exports, use and pathways to water emission of the substances. Based on this work, emission control measures under particular consideration of the situation in Germany were suggested.

The priority substances are very diverse in their use and formation, emission pathways, share of emissions into water as well as with regard to the quality and coverage of the available information. Therefore the substances were grouped together in several sets which shared some of the aspects cited (e.g. common area of application or origin, similar use/emission pathway, common data sources, comparable abatement possibilities). The groups are Heavy metals and their compounds, Polycyclic aromatic hydrocarbons, Chlorinated compounds – solvents, Chlorinated compounds – mainly intermediate products, Pesticides and Individual compounds with particular significance, see the following table.

Overview of the most important uses and emission sources for the priority substances in Germany

| Priority substance | Significant applications in Germany | Emissions |
|--|--|---|
| Lead | Storage batteries, semi finished products, alloys; construction industry, vehicles, hunting/fishing/diving sports | Heavy metals MONERIS: - urban/rural areas - municipal/ind. sewage plants - atmospheric deposition, historical pollution, ... |
| Cadmium | Batteries, (stabilizers, alloys) accompanying element of Zn, fertilizer | |
| Nickel | Steel, Ni-alloys, batteries, Ni-plating, catalysts | |
| Mercury | Chlor-alkali-electr., mercury batteries, fluorescent lamps, dental treatment (→crematoria) | |
| PAH (anthracene, fluoranthene naphthalene, PAH) | PAHs are formed in combustion processes; creosote (local emission); tar oil paints (ships, corrosion prevention); anthracene, fluoranthene, naphthalene: dyes, interim product | mainly via atmospheric deposition |
| 1,2-dichloroethane | Interim product in vinyl chloride production | emissions (air and water) from production of basic chemicals and waste treatment |
| Dichloromethane | industrial solvent and extracting agent, 10% as paint stripper to remove coatings | emissions from use as solvent (metal working), air emissions from open applications (atm. deposition estimated as low) |
| Trichloromethane (chloroform) | Interim product and solvent | emissions from use as solvent via wastewater and air pathways |
| Hexachlorobenzene | POP; no production, no use | emissions from use of fog-generating munitions; historical pollution of sediments/sites; by-product |
| Hexachlorobutadiene | no production, no use | By-product chlorine chemistry |
| Pentachlorobenzene | no production, no use; (source material for quintocene; prohibited since 1992) | historical pollution/sediments |
| Trichlorobenzene | Production; used as interim product | |
| Alachlor | not licensed | |
| Atrazine | not licensed | |
| Chlorfenvinphos | not licensed | |
| Chlorpyrifos | license for 2 products until 2015 as PPP; under review as biocide | |
| Diuron | licensed as PPP, under review as biocide | |
| Endosulfane (alpha-endosulfane) | not licensed | |
| Hexachlorocyclohexane (HCH) | no longer permissible for licensing in EU since 2002 | historical pollution one point source water direct (manufacturing inorganic basic chemicals) |
| Isoproturon | permitted | diffuse emissions via farming, increased by illegal/improper use, point emissions from farmyard run-offs |
| Simazine | prohibited | |
| Trifluralin | permitted i | |
| Benzene | large volume interim product, component of carburettor fuel (gasoline) | atmospheric deposition |
| Brominated diphenyl ether | flame proofing agent; since 8/2004 ban on marketing and use for penta- and octaBDPE (incl. products); decaBDPE in products | diffuse emissions DecaBDPE via imported products |
| C10-13-chloroalkanes | flame proofing agents, softeners; EU- | diffuse emissions via imported |

| Priority substance | Significant applications in Germany | Emissions |
|--|--|---|
| | wide restriction 2002/45/EC; no production in Germany | products, depot effect |
| Di(2-ethylhexyl) phthalate (DEHP) | PVC softener | emissions from PVC-processing, sewage plants, diffuse emissions via products and old products |
| Nonylphenols | Adhesive, varnishes; NPEO as tenside; restriction on use through 2003/53/EC | Emissions via NPEO (tenside); imported textiles; via PPP |
| Octylphenols | no longer produced in Germany; only very minor use | Emissions via impurities in NPEO |
| Pentachlorophenol | HSM/fungicide; prohibited since 1989 | historical pollution, emissions via imported products, depot effect |
| Tributyltin compounds | Anti-fouling paints: prohibited through 782/2003 and 2002/62/EC (implementation of IMO ban); | direct emissions during anti-fouling applications; shipyards; low emissions due to impurities in mono-/dibutyltin compounds |

For each priority substance a substance-specific data sheet was compiled in order to present the information and data in a compact form. These data sheets contain information on the following issues: Nomenclature and substance features, substance specific regulations, monitoring results, production and application, emission situation, approaches for emission abatement measures and literature. When possible, the findings are summarized in a figure like given for NP/NPEO below.

Figure: Fluxes for the NP / NPEO-use and resulting emissions for D (1999/2000)

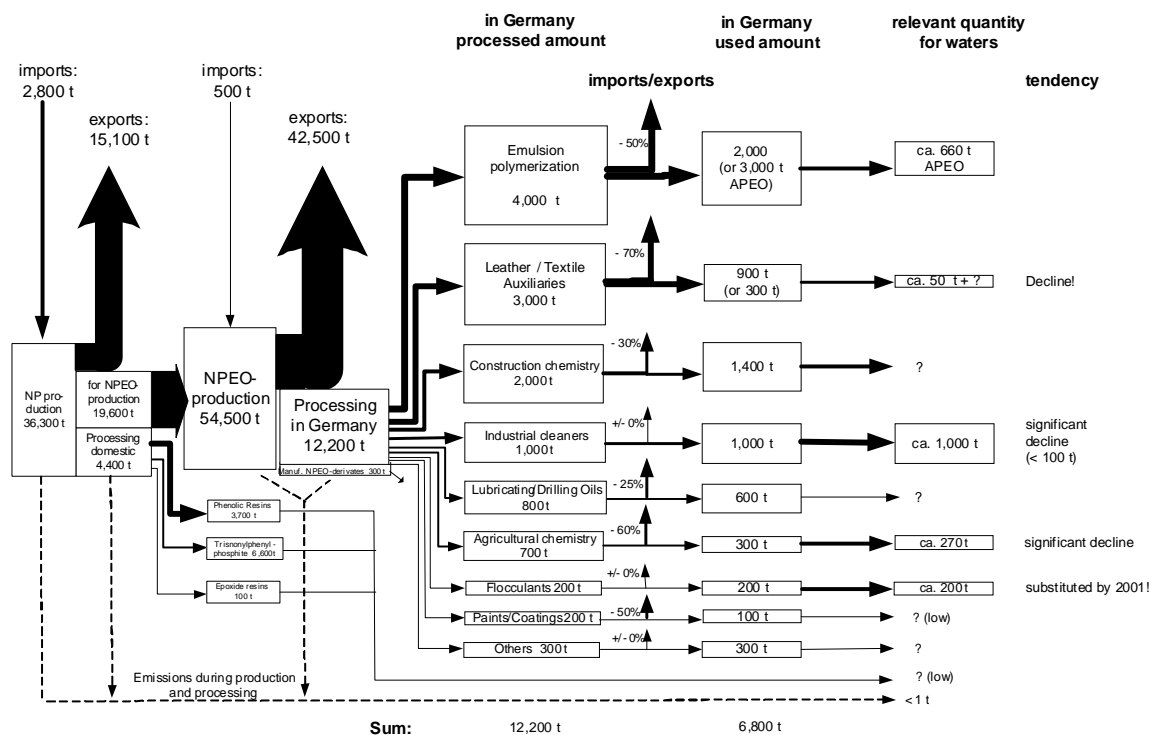

Germany case study fact sheet II

General information

country: Germany

title of the project/study:

Methodological optimization of nutrient and pollutant input modelling in river basins to promote the implementation strategy for the WFD

type: research project

scope:

- assessing relevance of source
- modeling of inputs
- inventory compilation

duration: 2009 – 2011

status:

- finalized

methodology used:

- regionalized path analysis:

information resources (URL):

<http://isww.iwg.kit.edu/MoRE.php>

<http://www.umweltdaten.de/publikationen/fpdf-l/4018.pdf>

contact person/organisation:

Karlsruhe Institute of Technology, Institute for Water and River Basin Management,
Department of Aquatic Environmental Engineering:

Dr. Stephan Fuchs (stephan.fuchs@kit.edu)

Abstract

Introduction

The Directives 2000/60/EC (WFD) and 2008/105/EC (on EQS) of the European Parliament and the Commission ask all Member States (MS) an inventory of emissions of priority substances for all RBDs (EU, 2000 and EP, 2008). This task requires appropriate data and approaches for the description of the current state of surface water bodies and the evaluation of appropriate measures for the reduction of emissions into the surface water bodies to achieve a good ecological state of surface water bodies and to meet the quality standards set.

Based on these requirements the proven MONERIS concept that was developed for modeling of nutrient emissions into the water bodies (Behrendt et al., 2000), was adapted as MoRE system (Modeling of Regionalized Emissions) for pollutant emissions. Besides the technical implementation,

a full documentation of input data, model approaches and results as well as transparency and flexibility of the model system have been realized.

Currently, MoRE is realized for Germany's large river basins and their catchment areas outside Germany with a total area of 650,000 km². The area is divided in about 3500 analytical units based on the drainage network. The analytical units can be aggregated to different administrative units, sub-basins or river basins. Given adequate input data, MoRE can be adapted easily to any other river basin or MS. The emissions can be modeled either in individual annual steps or for user-defined periods.

The MoRE system comprises approaches for the emission pathways: municipal wastewater treatment plants, industrial direct dischargers and emissions of historic mining for pathways related to point sources and the following emission pathways related to diffuse sources: sewer systems, surface runoff, erosion, groundwater, tile drainage, direct atmospheric deposition onto water surfaces and inland navigation (Figure 1). Thus, MoRE allows a regional and pathway specific quantification for any given aggregation unit. The modeling approaches and sources of input data are described in detail in Fuchs et al. (2010).

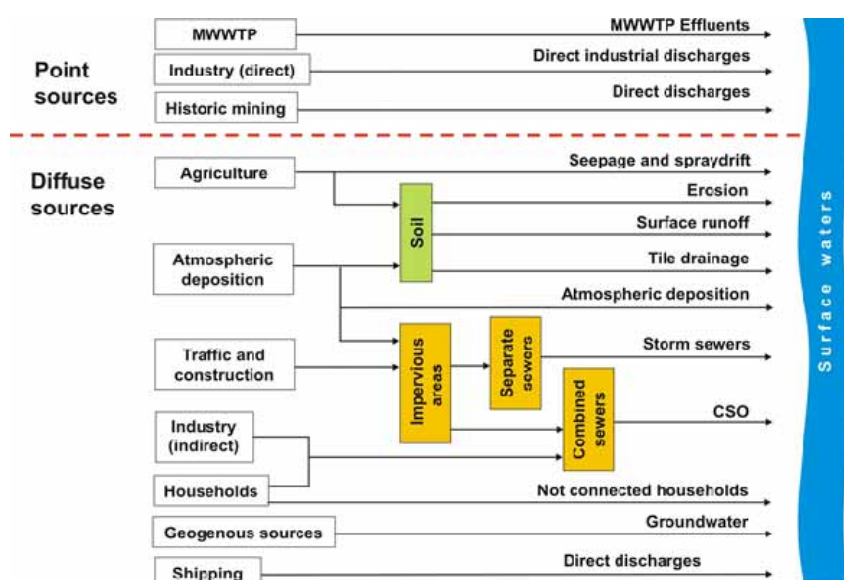

Figure 1: Sources and emission pathways considered (Fuchs et al., 2010)

Model architecture and implementation

This section describes shortly the model architecture with its components and the technical implementation of the MoRE system. Further information is available in Fuchs et al. (2011).

Model architecture

The MoRE system is based on an open source PostgreSQL database and two different graphical user interfaces (GUI): the MoRE Developer GUI and the MoRE Visualizer GUI (Figure 2). The GUIs have been developed for user interaction with the PostgreSQL database. The PostgreSQL database content can be easily read, changed and extended via the MoRE Developer GUI. The modeling can be launched via a calculation engine which is incorporated in the Developer GUI with a dynamic linkage to the PostgreSQL database. Modeling results can be visualized via a GIS-browser (MoRE Visualizer). Users can access the MoRE system either via internet on a multi-user basis or via a single user application for PC.

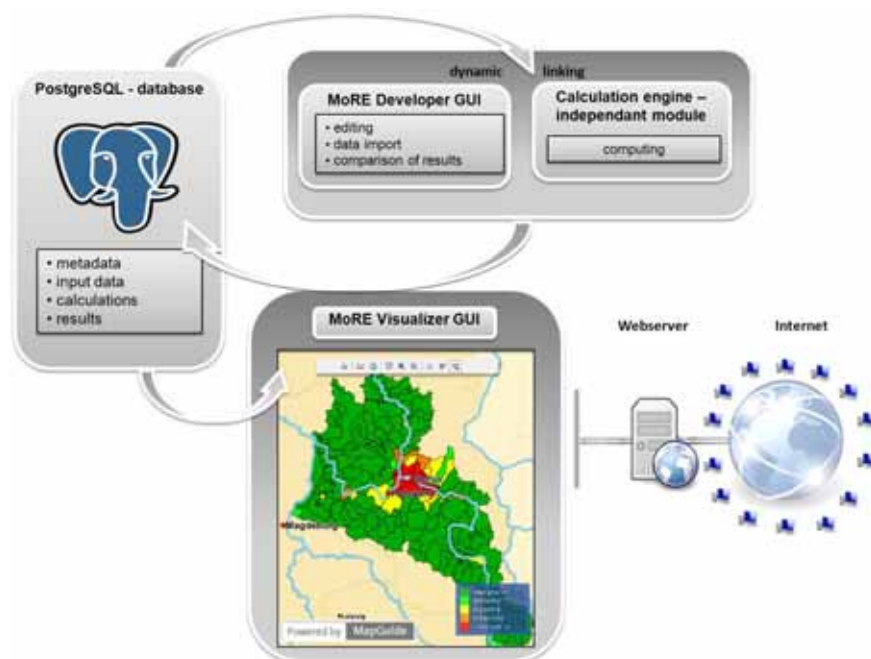

Figure 2: System architecture of MoRE

Calculation engine

One of the main goals of MoRE development was the provision of a flexible modeling tool. New modeling approaches can be integrated in a flexible way using the calculation engine and tested easily in the Developer GUI. This feature is possible because the calculation engine is integrated but unit independent of the database. That means the calculation engine does not include any equations but only the logic structure of the model and doesn't have to be adapted to changes in approaches, as long as the structure of the MoRE database will be maintained. The user does not need to have programming skills.

The database

The fundamental database contains all data and metadata for the spatial and temporal variables and for the model constants. This means, for example, that each record is assigned a unique origin and additional information like pathway specification and substance reference.

Furthermore, the empirical approaches are defined in the database. After modeling, the results can again be written to and stored in the database or exported for further analysis to MS Excel.

The MoRE database contains spatial and periodical input data. Input data is derived either from regionalized datasets like soil maps and hydrogeological maps, land use and population distribution datasets as well as from statistical data like connection rate to sewer systems, share of combined and separate sewer system, storage volume in combined sewer system. Additionally, emission factors like inhabitant specific loads and pollutant loads from impervious areas are implemented as constants. Altogether, the MoRE database contains about 300 variables, 12 million input data and 9 million results.

The graphical user interfaces

MoRE Developer

Using the MoRE Developer GUI, new input data can be added to the database and algorithms for approaches can be readjusted. Additionally, MoRE Developer owns a powerful calculation engine for calculating emissions and river loads for selected analytical units.

MoRE is modular, so that the approaches of individual pathways can be independently adjusted. Thus, alternative input data and modeling approaches can be implemented as variants of a basic variant. The results can be compared to evaluate the quality of the considered input data and approaches.

MoRE Visualizer

The MoRE Visualizer is a browser based application which works via a direct connection with the MoRE database. In addition to the MoRE Developer GUI, the MoRE Visualizer offers the opportunity of presenting and analyzing the computed data for selected aggregation units and periods.

After the selection and visualization of the data, it can also be presented as reports which can be exported to MS Excel.

Availability of MoRE

The MoRE system is Free Software. It is published under the licence AGPL V. 3 which allows free modifications, copying, redistribution and use of the software as long as the same terms also apply to the derivative works.

Exemplary results

Given the example of lead as one of the priority substances, we show exemplary model results. The total lead emissions from Germany account for 263 t/a (Fuchs et al., 2010). It turns out that erosion is the main emission pathway for lead besides sewer systems (Figure 3).

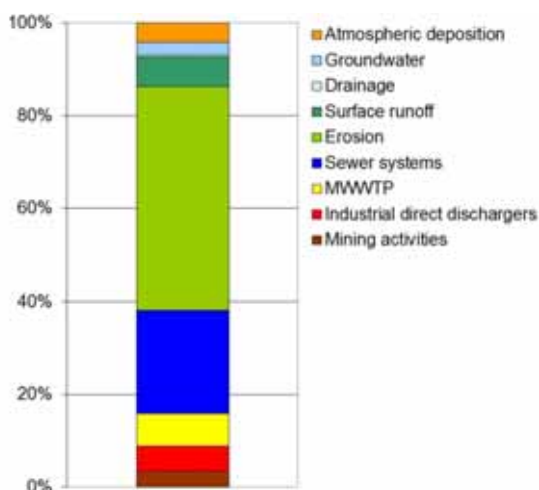

Figure 3: Relevance of the pathways for lead emissions into the RBDs of Germany in the balance period 2003-2005 (Fuchs et al., 2010)

Since MoRE generates regionalized emissions, the total emissions and the emissions for each pathway can be visualized on the level of analytical units. Using this map, one can detect pollution hotspots in river basins or administrative units (Figure 4)

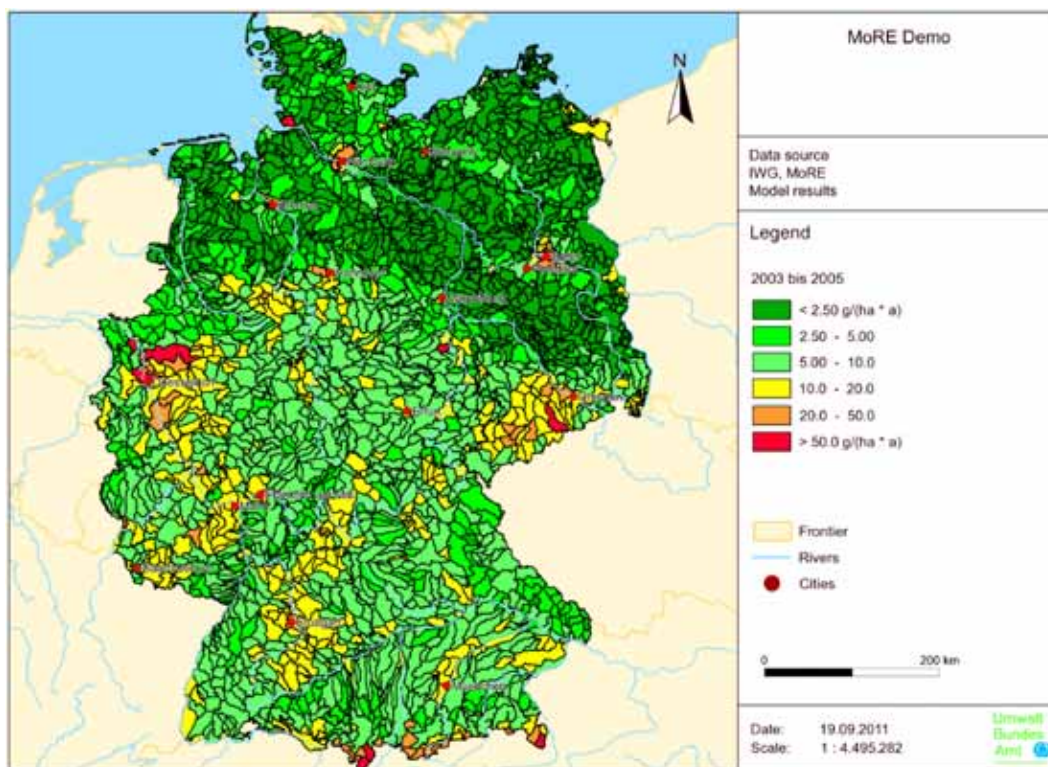

Figure 4: Specific lead emissions from the analytical units of Germany in the period 2003-2005

Conclusions

MoRE system is a flexible and transparent tool for the quantification of pollutant emissions in river basins. It allows a regional and pathway specific quantification for any given aggregation unit. Therefore, MoRE can be highly relevant for the allocation of investments or the implementation of specific measures to mitigate the overall pollutant emission into surface water bodies in order to meet the above mentioned requirements of EU water policy.

References

- Behrendt, H., Huber, P., Kornmilch, M., Ley, M., Opitz, D., Schmoll, O., Scholz, G. & Uebe, R. (2000): Nutrient Emissions into River Basins. UBA-Texte, 23/00
- European Parliament and the Council of the European Union (EP) (2000): Water Framework Directive (WFD) 2000/60/EC of the European Parliament and of the Council of 23 October 2000 establishing a framework for Community action in the field of water policy. EN Official Journal of the European Communities, L 327/1, p.72.
- European Parliament and the Council of the European Union (EP) (2008): Directive 2008/105/EC of the European Parliament and of the Council of 16 December 2008 on environmental quality standards in the field of water policy
- Fuchs, S., Scherer, U., Wander, R., Behrendt, H., Venohr, M., Opitz, D., Hillenbrand, Th., Marscheider-Weidemann, F., Götz, Th. (2010): Calculation of Emissions into Rivers in Germany using the MONERIS Model. Nutrients, heavy metals and polycyclic aromatic hydrocarbons. UBA-Texte 46/2010, Dessau
- Fuchs, S., Wander, R., Rogozina, T., Hilgert, S. (2011): The MoRE Handbook. Karlsruhe Institute of Technology. Institute for Water and River Basin Management. <http://isww.iwg.kit.edu/MoRE.php>

Belgium (Flanders) case study fact sheet

General information

country: Belgium

title of the project/study:

WEISS, the Water Emission Inventory, a planning Support System aimed at reducing the pollution of water bodies.

type:

Research project, financed by LIFE+ 08.

The result will be used for administrative practices.

scope:

- Information gathering (e.g. input loads or concentrations)
Existing monitoring data and estimated diffuse pollution data will be used, supplemented with data from additional research.
- Modelling of inputs
WEISS will model all the different pathways from source to surface water. Input will be monitoring data, calculated and estimated data.
- Inventory compilation
The WEISS system will act as an emission inventory and will calculate and report gross and net emissions at a high spatial resolution.
- Assessing relevance of source
WEISS will integrate all (relevant) emission sources and pollutants and will identify the significant emission sources.
- Decision support
Assist authorities in their monitoring and reporting obligations. Scenario calculation and planning support.

duration: 2010-2012

status: ongoing

methodology used :

WEISS is a model-based information system handling emission data from diffuse and point sources by means of geographical calculations at a high resolution.

WEISS uses a bottom up methodology in which it combines the advantages of the pathway oriented approach (POA) and the source oriented approach (SOA).

A pure source oriented approach, like Substance Flow Analysis (SFA), analyses all the flows of a substance in a well-defined system, including through industries producing and using it, households, wastewater treatment plants and all connected media such as soil, air and water. The substance flow of WEISS focuses on the end-use of a substance and it's connection to the medium water. Therefore WEISS is less complex than SFA, and has the advantage to report the emission on a high spatial resolution.

The pathway oriented approach focuses on the processes of transport to the surface water. These processes are also part of WEISS, and moreover, WEISS can report on the proportional contribution of sources to a certain transport.

information resources (URL):

<http://weiss.vmm.be>

contact person/organisation:

Flemish Environment Agency, Department Water Reporting
A. Van de Maelestraat 96, BE9320 EREMBODEGEM
Mrs Greta Vos (g.vos@vmm.be)

Abstract

Introduction

Monitoring and reporting the water quality for the Flemish region of Belgium is the responsibility of the Flemish Environment Agency (VMM). To assist in this tasks the WEISS system is currently under development in collaboration with the Flemish Institute for Technological Research (VITO). WEISS is a LIFE+ project that will create a geographically explicit, transparent inventory of emissions towards water for the Flemish region. The project will be realised in 3 years and will be finalised by the end of 2012.

The WEISS system

The WEISS system will integrate all relevant emission sources (both diffuse and point), all transport routes, and a planning support module. This will enable calculation of pollutant loads in distinctive nodes of the pathways, as required for monitoring and reporting (e.g. WFD, E-PRTR, WISE).

Sources and pollutants addressed in WEISS are typical for regions with a high pressure on land use. Pollutants from agricultural, urban and industrial activities will be quantified, with focus on priority substances.

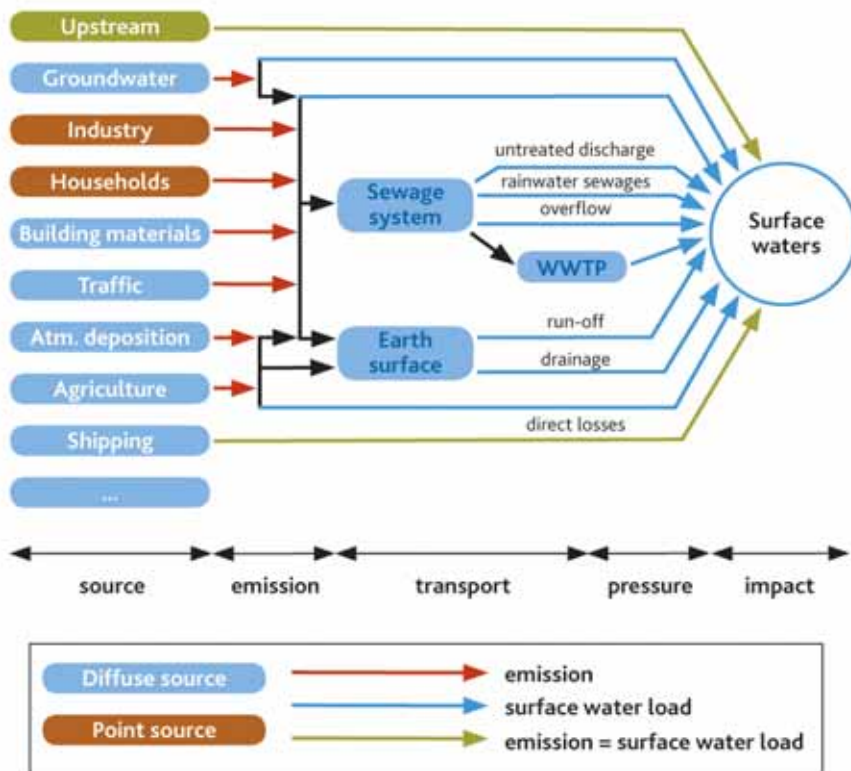

Pathways

WEISS focuses on emissions and their pathways to water bodies. In the flow scheme all the pathways considered in WEISS are represented. Reporting will be possible in each of the nodes.

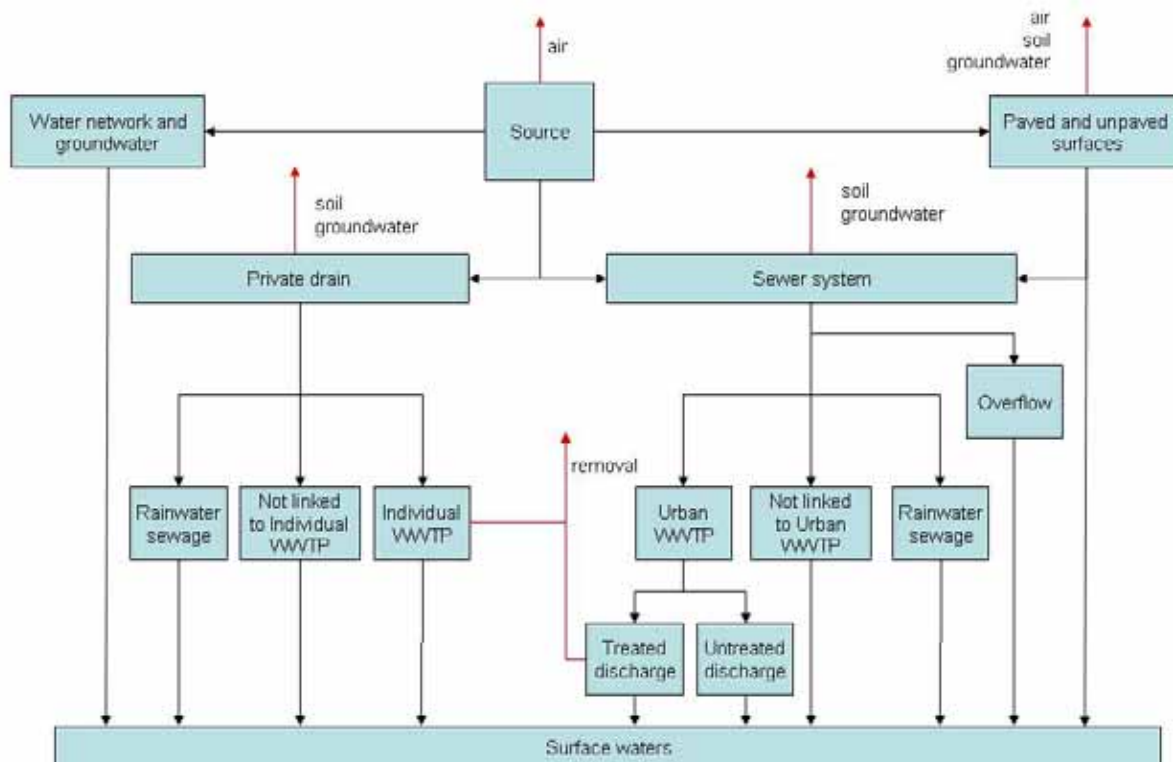

Flow scheme of WEISS: different pathways from source to surface water

High geographical resolution

WEISS will operate at a high geographical resolution. A resolution of 1 ha is selected for Flanders. The sources are spatially distributed on 1ha resolution maps before calculating the path of the emissions to surface water.

The base resolution can be changed in function of the sources dealt with, the spatial detail desired, the legislative framework, the quality and quantity of the original data and computational constraints.

Bottom-up approach

WEISS will use a bottom-up approach to calculate the emissions for each source and pollutant:

1. Localise the source (EEV) on high resolution map respecting its spatial characteristics (regionalization)
2. Apply Emission Factors (EF) to each grid cell where the source is present
3. Calculate in detail the loads transported via the relevant pathways
4. Summation of the loads for reporting of emissions in entities like water bodies.

In the model this bottom-up approach consists of three consecutive steps:

1. spatial distribution of the source,
2. computation of the pathways and
3. accounting in distinctive nodes of the pathways.

For every step, specific algorithms are applied. They are implemented as part of model blocks stored in a model library. For every emission source the appropriate model blocks are selected and chained to perform the required calculations. This modular approach allows the addition of new sources and new

pathways. The accounting module calculates the total pressure and source appointment for a chosen hydrological entity e.g. water body or river basin.

Adaptable

The system will be easily adaptable for use in EU MS or parts thereof and will be freely available to that effect. It will allow determination of the significant emission sources, simulate pathways from source to sink, support monitoring and reporting and assess (policy) measures aimed at reducing water pollution.

Conclusions

WEISS is a transparent emission inventory system with a generic approach that makes it easily adaptable. It uses a bottom-up approach that allows reporting at any geographical scale. The system can start small-scale or with data available at a low level, and can grow over time.

References

- Engelen, G. and Van Esch, L. (2008) De emissie-inventaris als instrument voor evaluatie en planning – deel: Haalbaarheid WEISS, Report 2008/IMS/R237, VITO, Mol.
- Engelen, G. and Van Esch, L. (2007) Evolutie van de emissies in water uit corrosie van bouwmaterialen aan de hand van de referentie jaren 1998, 2002 en 2005, Report 2007/IMS/R428, VITO, Mol.
- Engelen, G., Van Esch, L., Janssen, L., Van Holderbeke, M., Provoost, J., De Cuyper, K. and Dinne, K. (2006) Kwantificering en verfijning van het aandeel van de diffuse bronnen op de emissies naar oppervlaktewater in het stedelijk (gerioleerd) gebied. Deel: emissies van metalen te wijten aan corrosie van bouwmaterialen, Report 2006/I/MS/R397, VITO, Mol.
- Syncera Water B.V. (2005) Emissie-Inventaris Water, Syncera Water B.V., Delft.

France case study fact sheet

country: France

title of the project: French strategy for monitoring and reduction of hazardous substances discharges to waters from industry and urban wastewater treatment plants

type: implementation of a national strategy through a 2 steps process:

- A survey was first carried out on a sample of industrial and urban waste water treatment plants (2876 facilities)
- Use of the outcomes for regulatory purpose (revision of discharges permits)

scope:

- Information gathering: identification of point sources of hazardous substances
- Improvement of E-PRTR reporting on hazardous substances and as the result the quality of the inventory under EQS directive
- Assess the relevance of each source and target reduction measures
- Improve the management of industrial connections to urban wastewater networks
- Contribute to achieve the 2 main objectives of the WFD as far as chemicals are concerned: good status and reduction of emissions of substances.

duration: (start and end date)

The survey started in 2002 and ended in 2008.

Following this survey, 2 ministerial notices have been published and their implementation is ongoing.

- 2009/01/05: notice on the implementation of a specific monitoring of industrial discharges of hazardous substances to waters and their reduction
- 2010/09/29: notice on the implementation of a specific monitoring of UWWTP discharges of hazardous substances to waters

status: ongoing

information resources (URL):

The results of the survey together with the notice 2009/01/05 for industrial discharges monitoring and reduction are available in french on a dedicated website <http://ineris.rsde.fr/>

The french strategy on micropolluants reduction is summarised in a document that can be downloaded in french and soon in english at the following link: <http://www.developpement-durable.gouv.fr/Les-micropolluants-dans-les.html>

At the same link can be downloaded the notice 2010/09/29 for UWWTP discharges monitoring.

Methodology used:

Survey: monitoring of a list of 106 substances in the direct or connected discharges of 2876 plants.

Contact person/organisation:

French ministry for ecology, sustainable development, transport and housing (MEDDTL)

Lauriane Gréaud (lauriane.greaud@developpement-durable.gouv.fr): french strategy on micropolluants reduction

Marine Colin (marine.colin@developpement-durable.gouv.fr): industrial emissions

Vincent Ferstler (vincent.ferstler@developpement-durable.gouv.fr): urban wwtp emissions

Abstract

As a part of the global framework for the implementation of the WFD in France, a working programme has been initiated in 2002 which aims at reducing industrial releases of dangerous substances into the aquatic environment. This programme has 4 main steps:

1. Exploratory step: inventory of hazardous substances potentially discharged by industries and UWWTP to waters and identification of the most relevant substances to monitor
2. Improvement of knowledge and data consolidation: transitory monitoring
3. Implementation of a relevant monitoring at the site level
4. Carrying out of reduction actions

1. First step of the reduction strategy of hazardous substances point discharges: the national survey

From 2003 to 2007 took place in France a national inventory of hazardous substances in industrial and urban discharges to waters (called “action 3RSDE”). This action, initiated by the ministry in charge of sustainable development, was based on the chemical analysis of 106 chemicals in discharges from 2876 sites, mostly industrial facilities but also 167 urban wastewater treatment plants (UWWTPs) and 22 power plants. The sample of facilities involved in this action on a voluntary basis is considered representative of the French industry: chemistry, food product, paper manufacturing, surface treatment industry, metallurgy, textile, tanning, glass manufacturing, waste treatment and disposal...

Figure 1: Distribution of the 2876 facilities studied over the 6 French river basins

Sites étudiés dans le cadre de l'action nationale 3RSDE

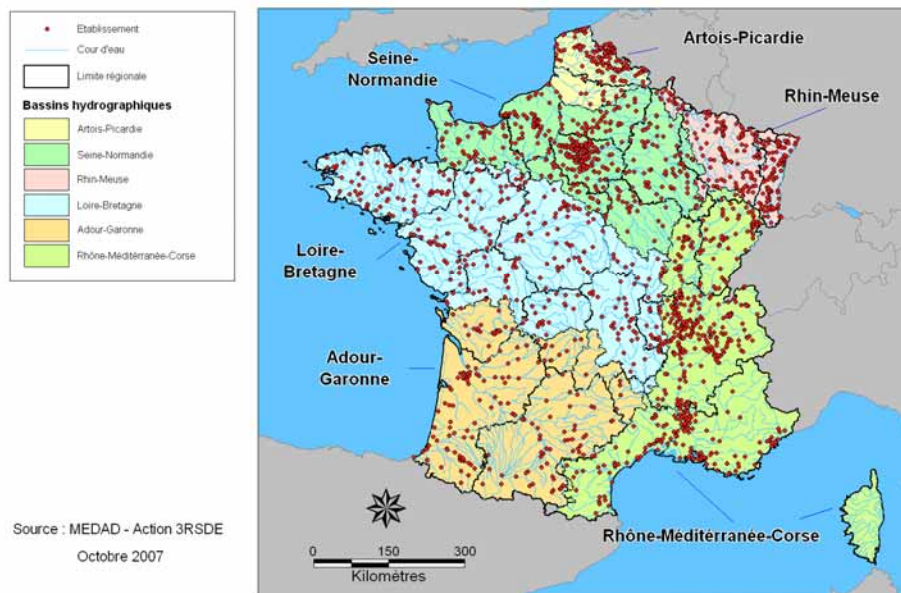

The list of 106 substances⁹ was established considering their toxicity for aquatic ecosystems and because they were subject to EU regulations on the limitation of their discharges to water (76/464/EEC - Dangerous Substances Directive - and 2000/60/EC - Water Framework Directive). Bioassays have also been performed on 10% of the effluents measured in order to begin a study on the possible correlation between chemical and ecotoxicological impacts.

Sampling prescriptions have been determined to be significant of a normal day of activity.

The 21 laboratories in charge of sampling and analyses had to comply with the same technical and quality requirements. Nevertheless, different analytical techniques were used and the associated performances introduced uncertainties in the results. The uncertainties are of course increased for “unusual” substances (not well known on routine basis) and for the low levels of concentrations.

All 106 substances have been quantified at least once, some in more than 30% of the discharges (metals, PAHs, VOHCs, phtalates).

70% of the measured emissions are organic substances. Some substances are quantified in the majority of sites but for 20% of them, a main source is observed.

This action made clear that urban wastewaters are also a source of hazardous substances as most of them (81) have been quantified in at least one discharge.

On the following figures, priority hazardous substances are identified in red and priority substances in yellow.

Figure 2: Substances quantified in more than 10% of the industrial discharges studied

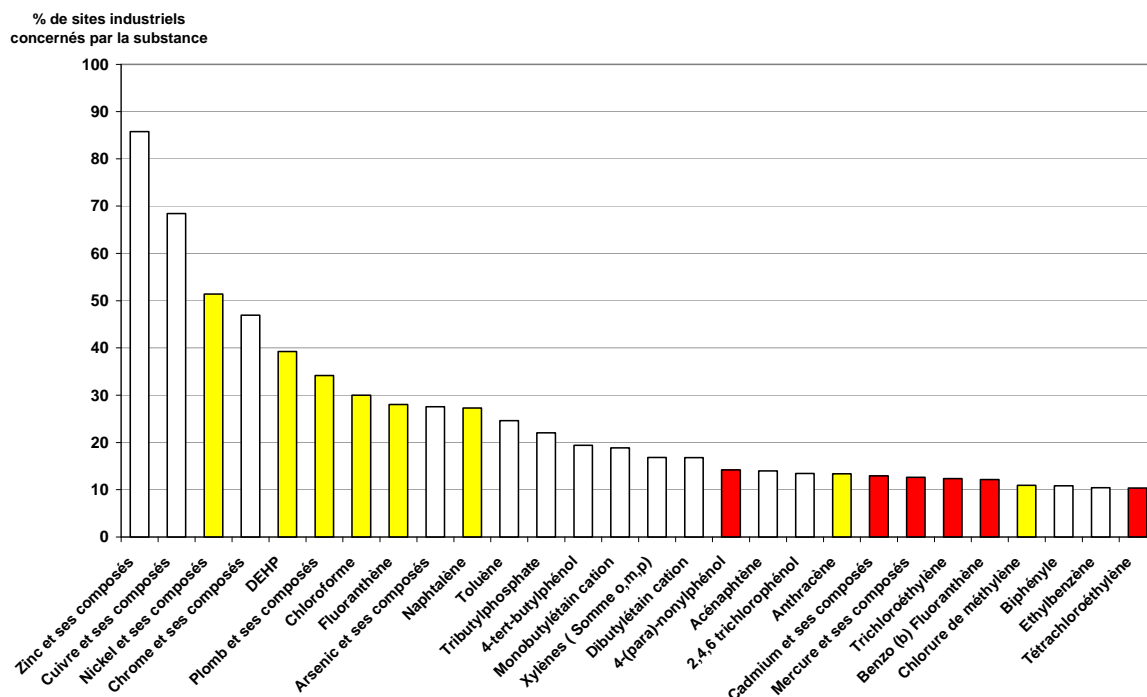

⁹ The complete results concerning this study can be downloaded (in French) at :

<http://www.ineris.fr/rsde/doc/docs%20rsde/DRC-07-82615-13836C.pdf> . The list of the 106 substances can be found p. 580 to 583.

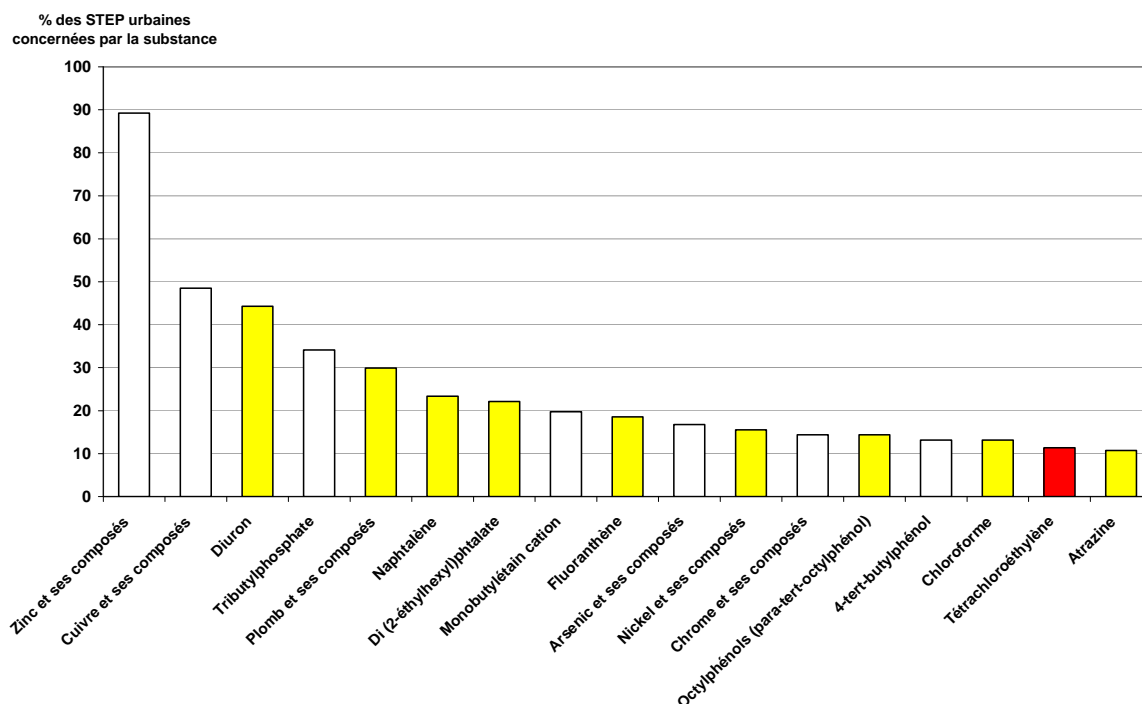
Figure 3: Substances quantified in more than 10% of the UWWTP discharges studied

The main outcomes of this inventory are:

- A great improvement of laboratories practices on these substances
- A better knowledge of hazardous substances point pollution sources, by the identification of key sectors involved
- Identification of working axes to elaborate appropriate reduction measures

In 2005, the first results of this survey, together with a similar survey carried out on surface waters, have been used to **select the substances of national concern**.

In 2008, negotiations with industrial sector representatives, on the basis of this results, lead to the elaboration of **39 sector specific lists of substances** that should be monitored in their discharges.

2. Second step: implementation of specific monitoring and reduction requirements of hazardous substances

2.1 Requirements for industry

In 2009, a notice from the ministry of sustainable development was published asking for the authorities in charge of delivering discharges permits to revise them in order to include the monitoring and, for some of them, the reduction, of relevant hazardous substances discharges for the industrial facility.

An initial monitoring has to be performed on a monthly basis, for a six month period. The list of substances to monitor depends on of the activities on site (39 sector specific lists established after the national survey).

Based on several criteria (loads, concentration, status of the water body...), some of the substances will be added to the self monitoring programme of the industry and for the ones with higher loads, a reduction action plan has to be established.

The substances entering to the self monitoring obligation have to be monitored on a quarterly basis, for 2 years minimum.

Annex 5 of the notice describes the technical requirements for chemical analysis and sampling. Limit of quantification (LoQ) that must be achieved are established for each substance.

Hazardous substances specific monitoring should be implemented in 2013 for all facilities under permit conditions.

The next step for the local authorities is to revise and add emission limit values in the permits, according to receiving the water body's allowance (based on EQS).

2.2 Requirements for UWWTP

In 2010, a notice from the ministry was published asking for the authorities in charge of delivering discharges permits to UWWTPs, to revise them in order to include the monitoring relevant hazardous substances.

An initial monitoring has to be performed on a monthly basis during a 4 months period.

For UWWTP above 100.000 eh capacity, the list of substances to monitor is adapted from E-PRTR regulation: implementation in 2011.

For UWWTP between 10.000 and 100.000 eh capacity, the list of substances to monitor is the list of UE priority substances and substances of national concern: implementation in 2012.

Based on several criteria (see above), a regular monitoring of some substances will have to be performed (see table 1). Then, every 3 year, monitoring of a larger list has to be carried out again.

Table 1: Monitoring frequencies for UWWTP

| EH | >=10.000 and t<30.000 | >= 30.000 and <90.000 | >= 90.000 and <360.000 | >= 360.000 and <540.000 | >= 540.000 |
|-----------------------------|--------------------------|--------------------------|---------------------------|----------------------------|------------|
| Number of analysis per year | 3 | 4 | 6 | 8 | 10 |

As for industries, this new monitoring requirement will be integrated in self monitoring requirements and permits will be revised.

Annexe 2 of the ministerial notice establishes the limit of quantification (LoQ) that laboratories must achieve for each substance. The technical requirements for chemical analysis and sampling are also described. For example, specific sampling equipment is required.

All these new requirements for industries and UWWTP also include the obligation to report the monitoring results together with the quality data through specific reporting tools. A quality check is performed by the ministry with the help of its technical agencies.

The creation of a national laboratory of reference for water (AQUAREF) has recently been supported by the ministry. This laboratory, which is a consortium of 5 structures, works at improving water monitoring results (natural or discharged waters).

Reference

LES SUBSTANCES DANGEREUSES POUR LE MILIEU AQUATIQUE DANS LES REJETS INDUSTRIELS ET URBAINS - Bilan de l'action nationale de recherche et de réduction des rejets de substances dangereuses dans l'eau par les installations classées et autres installations, L GREAUD et al, INERIS (2008)



Publications Office

ISBN 978-92-79-23823-9



9 789279 238239